

## User Manual

---

TouchMix-30 Pro Firmware Version 3.0

TouchMix-16 Firmware Version 3.0

TouchMix-8 Firmware Version 3.0



1001108-01-G



# EXPLANATION OF TERMS AND SYMBOLS

The term "**WARNING!**" indicates instructions regarding personal safety. If the instructions are not followed the result may be bodily injury or death.

The term "**CAUTION!**" indicates instructions regarding possible damage to physical equipment. If these instructions are not followed, it may result in damage to the equipment that may not be covered under the warranty.

The term "**IMPORTANT!**" indicates instructions or information that are vital to the successful completion of the procedure.

The term "**NOTE**" is used to indicate additional useful information.



The intent of the lightning flash with arrowhead symbol in a triangle is to alert the user to the presence of un-insulated "dangerous" voltage within the product's enclosure that may be of sufficient magnitude to constitute a risk of electric shock to humans.



The intent of the exclamation point within an equilateral triangle is to alert the user to the presence of important safety, and operating and maintenance instructions in this manual.



## IMPORTANT SAFETY INSTRUCTIONS



**WARNING!:** TO PREVENT FIRE OR ELECTRIC SHOCK, DO NOT EXPOSE THIS EQUIPMENT TO RAIN OR MOISTURE. Maximum ambient operating temperature is 40°C (104°F).

**WARNING!:** DO NOT LEAVE THE TouchMix-8 / TouchMix-16 POWER SUPPLY UNATTENDED WHEN PLUGGED IN. Always unplug the power supply from the electric outlet immediately after use.

1. Read these instructions.
2. Keep these instructions.
3. Heed all warnings.
4. Follow all instructions.
5. Do not use this apparatus near water.
6. Do not submerge the apparatus in water or liquids.
7. Do not use any aerosol spray, cleaner, disinfectant or fumigant on, near or into the apparatus.
8. Clean only with a dry cloth.
9. Do not block any ventilation opening. Install in accordance with the manufacturer's instructions.
10. Keep all ventilation openings free of dust or other matter.
11. Do not install near any heat sources such as radiators, heat registers, stoves, or other apparatus (including amplifiers) that produce heat.
12. To reduce the risk of electrical shock, the power cord shall be connected to a mains socket outlet with a protective earthing connection.
13. Do not defeat the safety purpose of the polarized or grounding-type plug. A polarized plug has two blades with one wider than the other. A grounding type plug has two blades and a third grounding prong. The wide blade or the third prong are provided for your safety. If the provided plug does not fit into your outlet, consult an electrician for replacement of the obsolete outlet.
14. Protect the power cord from being walked on or pinched particularly at plugs, convenience receptacles, and the point where they exit from the apparatus.
15. Do not unplug the unit by pulling on the cord, use the plug.
16. Only use attachments/accessories specified by the manufacturer.
17. Unplug this apparatus during lightning storms or when unused for long periods of time.
18. Refer all servicing to qualified service personnel. Servicing is required when the apparatus has been damaged in any way, such as power-supply cord or plug is damaged, liquid has been spilled or objects have fallen into the apparatus, the apparatus has been exposed to rain or moisture, does not operate normally, or has been dropped.
19. The appliance coupler, or the AC Mains plug, is the AC mains disconnect device and shall remain readily accessible after installation.
20. Adhere to all applicable, local codes.
21. Consult a licensed, professional engineer when any doubt or questions arise regarding a physical equipment installation.
22. Inspect the apparatus, including the power supply for signs of external wear and tear or signs of damage. All damage to the apparatus should be immediately repaired by a QSC authorized service station or QSC International Distributor. Failure to perform necessary repairs could lead to additional damage or to safety hazards. Failure to perform necessary repairs voids the limited warranty and QSC is not responsible for any injury, harm or related damages arising from any failure to perform those repairs.



## Maintenance and Repair



**WARNING!** Advance technology, e.g., the use of modern materials and powerful electronics, requires specially adapted maintenance and repair methods. To avoid a danger of subsequent damage to the apparatus, injuries to persons and/or the creation of additional safety hazards, all maintenance or repair work on the apparatus should be performed only by a QSC authorized service station or an authorized QSC International Distributor. QSC is not responsible for any injury, harm or related damages arising from any failure of the customer, owner or user of the apparatus to facilitate those repairs.

## FCC Statement



**NOTE:** This equipment has been tested and found to comply with the limits for a Class B digital device, pursuant to Part 15 of the FCC Rules.

These limits are designed to provide reasonable protection against harmful interference in a residential installation. This equipment generates, uses and can radiate radio frequency energy and, if not installed and used in accordance with the instructions, may cause harmful interference to radio communications. However, there is no guarantee that interference will not occur in a particular installation. If this equipment does cause harmful interference to radio or television reception, which can be determined by turning the equipment off and on, the user is encouraged to try to correct the interference by one or more of the following measures:

- Reorient or relocate the receiving antenna.
- Increase the separation between the equipment and receiver.
- Connect the equipment into an outlet on a circuit different from that to which the receiver is connected.
- Consult the dealer or an experienced radio/TV technician for help.

## Warranty

For a copy of the QSC Limited Warranty, visit the QSC website at [www.qsc.com](http://www.qsc.com)

Para una copia de la Garantía Limitada de QSC, visite el sitio web de QSC, en [www.qsc.com](http://www.qsc.com)

Pour obtenir une copie de la garantie limitée de QSC, visitez le site de QSC à [www.qsc.com](http://www.qsc.com)

Besuchen Sie die Webseite von QSC ([www.qsc.com](http://www.qsc.com)) um eine Kopie der beschränkte Garantie von QSC zu erhalten.

如果您想要QSC有限保修的複印本，請造訪QSC品的網站[www.qsc.com](http://www.qsc.com)

Для ознакомления с условиями ограниченной гарантии, посетите страницу компании QSC в интернете [www.qsc.com](http://www.qsc.com)

للحصول على نسخة من الضمان المحدود الخاص بـQSC، قم بزيارة الموقع الإلكتروني لشركة QSC للمنتجات الصوتية على [www.qsc.com](http://www.qsc.com)

# Table of Contents

---

<b>Maintenance and Repair</b> .....	iii
<b>FCC Statement</b> .....	iii
<b>Warranty</b> .....	iii
<b>TouchMix® How To</b> .....	1
<b>Register and Update</b> .....	1
<b>TouchMix-30 Pro Package Contents</b> .....	1
<b>TouchMix-8 / TouchMix-16 Package Contents</b> .....	1
<b>About This Manual</b> .....	1
<b>Getting Started</b> .....	1
Turn off Demo Mode .....	1
Recall a Factory Scene .....	2
What is a Scene? .....	2
Build a Mix Using Factory Presets .....	2
What is a Channel Preset? .....	2
Auxiliary Outputs .....	3
What is an Auxiliary? .....	3
<b>Effects</b> .....	3
Name the Effects Channels (or Mixes) .....	3
Using the FX Wizard .....	4
Using the Input Channel FX Tab .....	4
Pitch Correct .....	4
Using Pitch Correct .....	5
Using the FX Channel Effect Tab .....	5
Using the FX Overview .....	5
<b>Mute Groups</b> .....	6
<b>DCA Groups</b> .....	6
<b>Sub Groups (TouchMix-30 Pro only)</b> .....	7
<b>Using Auxiliaries as Sub Groups (TouchMix-8 and 16 only)</b> .....	8
<b>Matrix Mixing</b> .....	8
<b>Save Your Work as a Scene</b> .....	9
<b>Sound Check</b> .....	9
Using TouchMix with QSC Amplifiers and Loudspeakers .....	9
Loudspeaker Gain and Preset Pop-up .....	9
Select a QSC Loudspeaker Preset .....	10
QSC GXD Amplifier Settings .....	10
Phantom Power (+48V) .....	10

Work on Your Inputs .....	10
Simple and Advanced Mode .....	11
Auxiliary (Stage Monitor) Mixes .....	11
Input by Input .....	11
Mix On Faders .....	11
Output Processing .....	11
Overview Tab .....	12
PEQ Tab .....	12
GEQ Tab .....	12
Anti-Feedback Tab .....	13
Limiter Tab .....	13
Auxes Tab (TouchMix-30 Pro only) .....	13
Presets Tab .....	13
Setup Tab .....	13
Recording .....	14
Multi-Track Playback & Mix Down .....	16
Mix Down .....	16
DAW Interface .....	16
<b>Anti-Feedback System</b> .....	17
Manually Ringing Out a System .....	17
Using the Feedback Wizard .....	17
Pre-Feedback Wizard Checklist: .....	17
More about the Anti-Feedback System .....	18
<b>Real Time Analyzer (RTA)</b> .....	18
<b>Mutes</b> .....	19
<b>Copy &amp; Paste</b> .....	20
<b>Patch Matrix (TouchMix-30 Pro only)</b> .....	21
<b>Room Tuning Wizard</b> .....	22
TouchMix-30 Pro .....	22
TouchMix-8 or TouchMix-16 .....	22
<b>User Buttons</b> .....	24
<b>MIDI Control</b> .....	24
<b>Security</b> .....	25
<b>Monitor (TouchMix-30 Pro only)</b> .....	26
<b>Monitor (TouchMix-16 only)</b> .....	26
<b>Solo In Place (SIP) (TouchMix-30 Pro only)</b> .....	26

<b>TouchMix Reference</b> .....	27
<b>Getting Started</b> .....	27
Top Panel and Remote-Device Controls (TouchMix-30 Pro) .....	27
Rear Panel (TouchMix-30 Pro) .....	28
Right Side of the TouchMix-16	
Mixing Surface .....	30
Right Side of the TouchMix-8	
Mixing Surface .....	31
Rear Panel (TouchMix-16) .....	32
Rear Panel (TouchMix-8) .....	32
TouchMix-30 Pro Specifications .....	33
TouchMix-8 and TouchMix-16 Specifications .....	35
TouchMix™ Feature List .....	37
<b>Nav Strip</b> .....	39
Channel Controls .....	40
<b>Input Channels</b> .....	41
Input Channel – Overview .....	41
Input Channel – Analog Trim .....	43
Input Channel – EQ .....	44
Input Channel – Compressor .....	45
Input Channel – Gate .....	46
Input Channel – FX Sends .....	47
FX Signal Flow .....	47
Input Channel – Aux Sends .....	48
Auxiliary Channels Flow Diagram .....	48
Input Channel – Presets .....	49
Input Channel – Setup .....	50
<b>Output Channels</b> .....	51
Output Channel – Overview .....	51
Output Channel – GEQ .....	52
Output Channel – PEQ .....	53
Output Channel – Compressor / Limiter .....	54
Output Channel – Anti-Feedback .....	55
Output Channel – Auxes	
(TouchMix-30 Pro only) .....	56
Output Channel – Presets .....	57
Output Channel – Setup / Delay .....	58
Output – Speaker Settings .....	59
GXD Amp Settings .....	59
On the GXD Amplifier .....	59
On the TouchMix .....	59
Aux Overview .....	60

<b>Sub Groups (TouchMix-30 Pro only)</b> .....	.61
Sub Group – Overview .....	.61
Sub Group – PEQ .....	.62
Sub Group – Compressor / Limiter .....	.63
Sub Groups – FX Sends .....	.64
Sub Group – Auxes .....	.65
Sub Group – Presets .....	.66
Sub Group – Setup .....	.67
<b>2-Trk Playback</b> .....	.68
2-Trk Playback – Overview .....	.68
2-Trk PB – EQ .....	.69
2-Trk Playback – Audio Player .....	.70
2-Trk Playback – Auxes .....	.71
2-Trk Playback – Presets .....	.72
2-Trk Playback – Setup .....	.73
2-Trk / Multitrack Playback .....	.74
<b>FX Masters</b> .....	.75
FX Master – Overview .....	.75
FX Masters – EQ .....	.76
FX Masters – Presets .....	.77
FX Master – Setup .....	.78
FX Master – Auxes .....	.79
FX Overview .....	.80
<b>Wizards</b> .....	.81
FX Wizard .....	.81
Gain Wizard .....	.82
Room Tuning Wizard .....	.83
<b>FX Processor</b> .....	.85
FX Processor – Basic Chorus .....	.85
FX Processor – Dense Reverb .....	.86
FX Processor – Lush Reverb .....	.87
FX Processor – Mono and Stereo Delay .....	.88
FX Processor – Pitch Shift .....	.89
FX Processor – Pitch Correct .....	.90
Remote Connections .....	.91
<b>Security</b> .....	.92
Login Screen .....	.92
Security Setup .....	.92



<b>Miscellaneous Features</b> .....	93
Menu .....	93
Remote Control Settings .....	94
User Buttons .....	95
User button defaults: .....	95
Mixer Setup .....	96
Phantom Power .....	97
<b>Mute Groups</b> .....	98
About Mute Groups .....	98
Mute Groups Screen .....	98
Mute Group Edit Screen .....	98
Record / Playback (Multitrack USB Drive) .....	99
Record / Playback – Main Screen .....	99
2-Trk – Recording .....	100
2-Trk Recording Setup .....	100
DAW – Record / Playback (TouchMix-30 Pro only) .....	101
Real-time Analyzer (RTA) .....	102
Scenes .....	103
Channel Safe .....	104
Auto Mixer TouchMix-30 Pro .....	105
Description .....	105
Accessing the Auto-Mixer .....	105
Auto-Mixer Controls and Indicators .....	105
External Control Surfaces - TouchMix-30 Pro .....	106
Channel Strip View .....	106
Custom Fader Banks - TouchMix-30 Pro .....	107
Set up the Custom Fader Banks .....	107
DCA Group Assignments .....	108
About DCA Groups .....	108
MIDI .....	109
Talkback / Noise .....	110
<b>TouchMix Wi-Fi Control</b> .....	111
Before You Begin .....	111
Wi-Fi Router Access Point .....	111
Setting it up .....	111
Connecting to a Facility's Network .....	111
Wireless Network Setup: Create New Network .....	112
Wireless Network Setup: Connect to Existing Network .....	113
Wired Network Setup: Static IP Address .....	114
Wired Network Setup: Auto IP Address (DHCP) .....	115

TouchMix-30 Pro Phones and Monitor .....	116
Phones Level .....	116
Monitor Level and Settings .....	116
TouchMix-8 and TouchMix-16 Phones and TouchMix-16 Monitor .....	116
Recording Setup – Multitrack USB .....	117
Recall Session – Multitrack USB .....	118
Aux Mix on Faders .....	119
TouchMix-30 Pro .....	119
Summary .....	119
Control Descriptions: .....	119
Patch Matrix (TouchMix-30 Pro only) .....	120
Using the Patch Matrix .....	120
Copy and Paste .....	121
<b>TouchMix-30 Pro Firmware Version 3.0 Features</b> .....	123
<b>Scenes, Snapshots and Cue Lists</b> .....	123
Scenes .....	123
Snapshots .....	124
Cue Lists .....	125
<b>TouchMix Dimensions</b> .....	126
<b>TouchMix-30 Pro</b> .....	126
<b>TouchMix-8</b> .....	127
<b>TouchMix-16</b> .....	128
<b>TouchMix Block Diagram</b> .....	129
<b>Mic/Line Input Channels</b> .....	129
<b>Stereo Input Channels</b> .....	130
<b>Main Output</b> .....	131
<b>Stereo Auxiliary Output</b> .....	132
<b>Mono Auxiliary Output</b> .....	133
<b>Stereo Sub Group (TouchMix-30 only)</b> .....	134
<b>Mono Sub Group (TouchMix-30 only)</b> .....	135
<b>Cue, Monitor, Talkback, Noise</b> .....	136
<b>FX Return</b> .....	137
<b>2-Track Playback</b> .....	138
<b>RTA (Real Time Analyzer)</b> .....	139
<b>Contact QSC</b> .....	140

# TouchMix® How To



**IMPORTANT:** This User Manual applies to mixers with TouchMix-30 Pro Firmware Version 3.0, or TouchMix-8 and TouchMix-16 Firmware Version 3.0 installed. Earlier firmware releases do not support all of the functions described and some operations may differ.

## Register and Update



We know you want to get right to using your TouchMix mixer, but before you do please stop and take a moment to visit [www.qsc.com](http://www.qsc.com) and register your TouchMix. By registering you can...

- Download the latest firmware so that your mixer has all the latest features, refinements and performance enhancements.
- Sign up to be notified of future updates.
- Check to see if you are eligible for free extended warranty coverage.

While you're there, you can also find videos and other tools to help you get the most from your TouchMix-30 Pro.

## TouchMix-30 Pro Package Contents

1. TouchMix-30 Pro Mixer
2. Quick Start Guide TouchMix-30 Pro (TD-000509)
3. Warning Information Sheet (TD-000430)
4. Limited Warranty (TD-000453-01 English)
5. One of the following power cords
6. North America TouchMix-30 Pro, 2M, V-Lock
7. Europe TouchMix-30 Pro, 2M, V-Lock

## TouchMix-8 / TouchMix-16 Package Contents

1. TouchMix-16 or TouchMix-8
2. Quick-Start Guide (TD-000445 or TD-000446)
3. Warning Information Sheet
4. Limited Warranty (TD-000453-01 English)
5. USB Wi-Fi adaptor (installed in mixer's USB port)
6. Power supply with IEC cable (AC connector type varies by region)
7. TouchMix carrying case

## About This Manual

This manual covers the features and operation of the TouchMix-8, TouchMix-16 (with firmware version 3.0) and TouchMix-30 Pro (with software version 2.0). These mixers share many features and operational similarities but differ in other respects – most significantly, input and output channel count. Features and functions that are unique to just one model are identified as such.

## Getting Started

Since your TouchMix is a digital mixer there are lots of things you can do off-line to save time during setup and help you get acquainted with your mixer. We highly recommend spending a little quality time with the mixer before taking it to a show for the first time.

## Turn off Demo Mode

Demo mode is a looping slide show that plays as a factory default to give prospective buyers an overview of the mixer. You'll probably want to turn Demo Mode off – even though our graphics guys are really proud of how it looks.

To Disable Demo Mode: 

## Recall a Factory Scene

### What is a Scene?

Scenes allow storage and recall of mixer settings. A Scene includes all channel-processing settings, channel Names, Phantom Power settings, Effects selections, DCA, Sub Group and Mute Group assignments. Scenes also include level settings. Factory scenes are stored with input faders at minimum to prevent any surprises (feedback, music at 20 dB above the threshold of pain, etc.) when the scene is recalled. User scenes are stored with levels set as they were when the scene was saved. User scenes may be stored to internal memory and to an external USB storage device.

There are circumstances when it's useful to recall a scene but omit certain settings from being changed. The TouchMix-30 Pro offers these Recall Options:

- Omit Levels: When switched on, the scene will be recalled without making any change to any level settings.
- Omit Outputs: When switched on, the scene will be recalled without making any change to any output EQ, comp/limiter or level settings. This is especially useful when recalling a scene after the mixer's outputs have been adjusted for a particular venue and speaker system.
- Omit Routing: When switched on, the scene will be recalled without making any change to routing such as Sub Group assignments and pre/post selections.

Your TouchMix is loaded with pre-defined scenes for various kinds of performances. You can find the one that's most like the show you'll be mixing and start there.

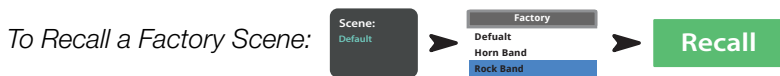

The factory scenes list includes a scene named Default. This scene will “zero” the mixer by returning all controls to their factory settings.



If you'd like to navigate around the mix and see what the recalled settings are, return to the  screen.

## Build a Mix Using Factory Presets

### What is a Channel Preset?

A Channel Preset consists of settings for a single channel that are saved and can be recalled for use at a later time. A Channel Preset includes settings for the channel EQ, Compressor and Gate. The channel name, phantom power setting and level settings are also stored with the preset but may be omitted from a preset recall by setting the Recall Options switches at the bottom of the presets screen.

Your TouchMix includes over 120 channel presets that were programmed to work with common microphones in real, live sound applications by skilled and experienced concert-sound mix-engineers. And they work. Those who have used TouchMix-30 Pro report great results using the presets with little or no modification. You can also save your own channel presets to the mixer's internal memory or to an external USB storage device.



1. Make sure that the Factory / User switch is in the Factory position.
2. In the left window you'll see a list of instrument categories. Touch an instrument category name and a list of specific instruments appears in the middle window.
3. Select a type of instrument and the right window will display a list of options for that instrument. There may be options with and without gates and compressors as well as options for various types of microphones and pick-ups or different styles of music. Select the one that seems best for your application.



You've just dialed in the settings for an input channel. You'll also notice that the channel has been given a name that corresponds with the instrument you selected. You can leave the name as is or rename the channel.



Repeat the process until you've set up all the channels you need.

## Auxiliary Outputs

### What is an Auxiliary?

In addition to the Main L/R (left/right) output mix, your TouchMix mixer is capable of controlling 4 (TouchMix-8), 8 (TouchMix-16) or 14 (TouchMix-30 Pro) additional output mixes.

These Auxiliary mixes are typically used to drive stage monitor speaker systems or in-ear monitors (IEM) for performers. They may also be used for a recording mix, audio feed to video or a send to an overflow area. In any case, it makes sense to label the auxiliary outputs to help keep them straight during use. Type in a name for the output – it could be the name of the performer who gets that mix or it could be something like “Singers” or “Horns” or “Video” or “Patio”.



The name will be displayed on the aux mix selector buttons on the left side of the screen.

Auxes may also be linked so that two mono mixes become one stereo mix.



**TouchMix-30 Pro** – A pair of TRS headphone outputs labelled Aux 11/12 and Aux 13/14 may be found on the mixer's rear panel. These outputs receive their signal from the corresponding Auxiliary Mixes and are intended to drive wired, In Ear Monitors (IEM). If using these outputs, it's recommended that the Auxiliary mixes driving these headphone outputs be linked for stereo operation.

**TouchMix-8** – A single TRS headphone output labelled Aux 3/4 may be found on the mixer's rear panel.

**TouchMix-16** – A pair of TRS headphone outputs labelled Aux 7/8 and Aux 9/10 may be found on the mixer's top panel. These unbalanced, stereo outputs may also be configured as balanced, mono, line-level outputs (see the Aux output channel Setup tab).

## Effects

Audio effects (FX) such as reverb, delay, chorus, pitch shift (pitch change) and pitch correct are essential in today's audio production.

The TouchMix-30 Pro has six multi-effects processors or “engines” while the TouchMix-8 and TouchMix-16 have four. All of these processors may be configured to be one of six different effects including Lush Reverb, Dense Reverb, Chorus, Mono Delay, Stereo Delay and Pitch Shift.

Each of these effects have multiple presets. The reverb processors, for example have presets simulating various sizes of rooms and halls as well as reverb plates. In addition, there are brighter and darker sounding variations.

Along with the above effects, there is a Pitch Correct effect that can be assigned (inserted) to any one of the input channels.

### Name the Effects Channels (or Mixes)

In the middle of a show it's easy to forget which effect was intended for what performers or instruments so this would be a great time to name the Effects Send channels. For example, you might name an FX channel “Voc Delay” or “Drum Rev”.





## Using the FX Wizard

Less experienced users will find that the FX Wizard simplifies what can be a confusing process while skilled operators will find it to be incredibly fast. With the FX Wizard you can quickly...

- Select an effect that's right for the instruments or voices you want to enhance.
- Bring the instruments or voices into the effect.
- Adjust the overall amount of the effect that will be heard.
- Send the effect to monitors as you desire.



Select an effect preset. Only effects that work for the Source and Type of input you have selected will be shown. So any effect you select using the wizard will be a valid one although it may or may not work in the context of your mix

Select an Effect Preset:

1. Use the Master Encoder or touch-and-drag to scroll up and down the list to see all the selections. Select one item from each list.
2. Touch Recall. The Preset is now loaded, and the name is displayed below the Type window.
3. With the Preset loaded, it's time to decide which input channels should go to the FX1 processor.

Send inputs to the FX processor:

4. Buttons with the names of inputs are displayed on the Wizard Screen. Touch any button to send an input to the effect. Use the FX Master fader to adjust the amount of effect heard in the main mix.

Send the effect to monitors:

5. Is the performer going to want to hear the effect in the stage monitors or in-ear monitors? If so, it's easy to send it there. Just use the "Select Aux Outputs (monitors) to receive:" buttons to route the effect to a monitor.
6. There are more effects available so touch one of the tabs at the top of the screen to set up more effects.

## Using the Input Channel FX Tab

The FX tab on the Input Channels provides another way to select and control effects.



Once in the Channel FX screen, you can...

- Go to the Effects Processor's control panel by touching a control panel icon. Press Home to come back.
- Use the sliders to control the amount of signal sent from the channel to each of the Effects Processors,
- Adjust the two most important parameters for each Effect using the "Global FX Parameters" controls. Note that any adjustment made to these controls is global and will change the Effect everywhere it is used.

## Pitch Correct



The Pitch Correct Effect is somewhat different than the Reverb, Delay, Chorus and Pitch Shift Effects. Pitch Correct can only be used on one input channel at a time and there is one Pitch Correct effect. When it is assigned to a channel, it will be unassigned from any channel to which it was previously assigned.

Touch the Enable button to assign Pitch Correct to the currently selected channel.

## Using Pitch Correct

Use the Blend control to vary the mix between corrected (wet) and uncorrected (dry) signal. 100% wet is used to correct pitch. A blend between wet and dry is used to provide a doubling effect.

Use the Key control to select a musical key. This helps Pitch Correct be more accurate in determining what the intended note is.

Use the Correct Rate control to adjust how quickly the pitch correction tracks.

## Using the FX Channel Effect Tab

Go to the FX Channel Effect Tab (From the Input Channel FX tab):



Touch the Effect window to select the type of effect.

- Chorus
- Stereo Delay
- Pitch Shift
- Dense Reverb
- Lush Reverb
- Mono Delay

Once an Effect is selected touch the Preset Tab. From this screen select a preset setting for the effect. Note that the setting can include EQ. Factory presets are displayed in the left-hand window. User presets may be stored and recalled using the center and right-hand windows.

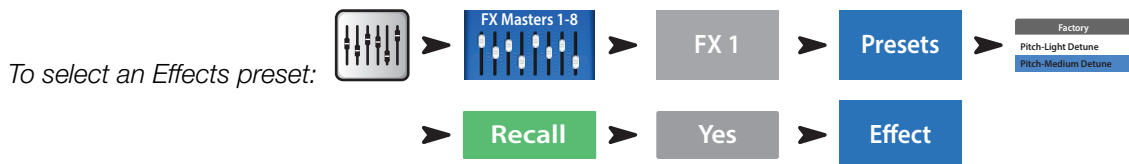

Touch the Effect Tab to return to the Effect Processor control panel. Each type of Effect Processor displays a different control panel with parameters appropriate for the Effect.

Use the FX Master fader to the right of the FX panel to adjust the amount of effect heard in the main speaker system.

To adjust the level of the Effect sent to the Main L/R Output:

Below the Effect control panel is the FX Returns to Monitors section. Use the sliders to set how much of the effect is sent to each auxiliary / monitor mix. If two auxiliaries have been linked, a slider and a pan control will be displayed. Above each slider is a channel label and a Mute [M] indicator.

## Using the FX Overview

If you would prefer to see the send and return levels for all your effects at once, the FX overview is the place to go.



1. Input channels are arranged in columns. Use the Nav Strip to select a group of Input channels. Each Input channel sends for FX Sends 1–4 (TouchMix-8 and TouchMix-16) and 1 – 6 (TouchMix-30 Pro).
2. Individual FX Mixes are arranged in horizontal rows.
3. FX Master fader – The FX Master fader controls the overall output level of the FX Mix to the Main L/R outputs. Note that the FX Master does not affect the level of the Effect sent to the Aux channels.
4. Effect Processor – Indicates the type of Effect currently being applied to the FX Mix.

So that's about it for effects. We worked hard on the TouchMix effects and know that they sound superb and will enhance your performances. You can dive in deep or just use the wizards, factory defaults and presets. Either way, you now have the tools for a great sounding show.

## Mute Groups

There are many times when it is useful to mute some of the inputs and outputs. For example, you might want to mute everything but a stereo input for break music. Or there may be a part of your show when the band leaves the stage while one member does a solo number. Mute groups let you mute multiple inputs and outputs from a single button. For more information on mutes, see ["Mutes" on page 19](#)

To set up Mute Groups:  ➔  ➔  ➔  Select channels to be assigned

To name the Mute Group:  **New Verb**

Select another Mute group to set up or touch  Close Edit to finish.

To use Mute Groups:  ➔  ➔ 



**NOTE:** Mute Groups can be assigned to the User Buttons. ["User Buttons" on page 24.](#)



**NOTE:** When a channel is muted by a Mute Group, the channel Mute button on the Home screen looks like: 

## DCA Groups

A DCA groups faders together so the overall level of all the channels in the group can be controlled by a single DCA fader. A DCA fader does not change the position of any of the faders in the group.



**IMPORTANT:** Here is an important thing to know – if the DCA master fader is at 0.0 (the unity (U) mark), it does nothing to the level of an assigned channel. The DCA adds or subtracts level. Move the DCA Fader up 3 dB and everything it's assigned to will increase by 3 dB. Move it down 3 dB and – well you probably figured that out. Remember that assigning or unassigning a channel to a DCA Group can cause a sudden change in the level of the channel so it's good practice to have the DCA master at 0.0 when changing assignments.

To Setup a DCA Group:  ➔  ➔  ➔  ➔  Continue selecting channels as you wish.

You can assign inputs, outputs and FX Master faders to a DCA. If you assign an input, and the output to which it's going to the same DCA, changes you make using the DCA are doubled for the input. Raise the DCA 3 dB, the input is effectively raised 6 dB.

To Name the DCA group:  **Drums**

To Mute a DCA Group:  ➔  ➔  ➔ 

When you mute a DCA, all channels assigned to that DCA are muted. If a channel is muted by the channel Mute button, or a Mute Group, the DCA does not un-mute the channel when the DCA is un-muted.

## Sub Groups (TouchMix-30 Pro only)

Like DCA Groups, Sub Groups are used to control the volume of multiple channels at once. However, DCA Groups simply add or subtract gain for the channels they control. No signal is routed through a DCA. Unlike DCA Groups, signal is routed through Sub Groups. This means that Sub Groups can apply processing including EQ, Limiting and even Effects to multiple channels. There are basically three ways that Sub Groups are used...

- To apply common processing and level control to multiple inputs and return the processed group to the Main L/R mix.
- To route a group of inputs to an external destination such as a broadcast mix. These output groups are commonly referred to as “stems”.
- To route a blend of Sub Groups to an external destination.

All eight Sub Groups appear on the Auxiliary mixes.



There are two ways to assign Input Channels to Sub Groups.

### From an Input Channel

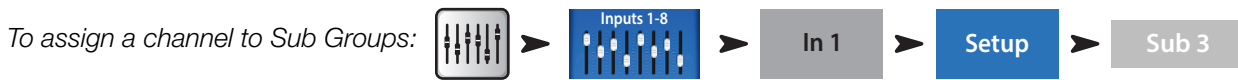

If the Sub Group is going to be sent to the Main L/R output, the channel should usually be unassigned from Main L/R. Otherwise the channel's signal will be sent directly to the Main L/R output (without any processing) and also sent to the Main L/R by way of the Sub Group. There are some advanced use cases where such a double assignment may be desirable but typically that is not the case.

### From a Sub Group



This will take you to the Sub Group Setup page.

The lower portion of the page displays the numbers and friendly names of the input channels. Touch the button of the channels you wish to assign to the Sub Group. If the channel is assigned to the Main L/R mix, an [L/R] icon will appear by the button,



**NOTE:** "Remove Input Channel from L/R when assigning to Sub Group?"

In the "Yes" position, assigning an input channel to a Sub Group will cause the input to be unassigned from the Main L/R. In the "No" position, assigning a channel to a sub group will have no effect on the channel's Main L/R assignment.

## Using Auxiliaries as Sub Groups (TouchMix-8 and 16 only)

The Auxiliary mixes may be assigned to the Main L/R output allowing the auxiliaries to function as sub groups. This feature is intended for use with the input channel "Assign To Main L/R" function.

To use an Auxiliary channel as a Sub Group (for this example, we are assigning In Channel 1 to Aux 5 Sub Group):

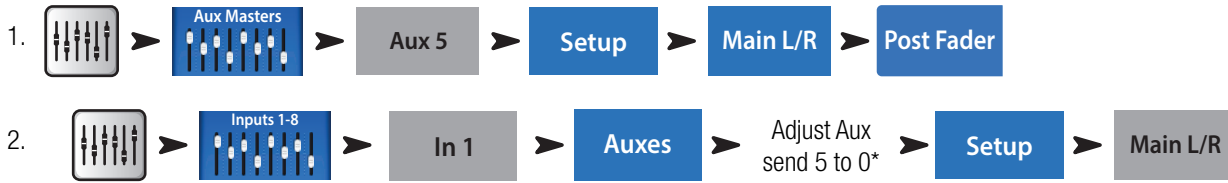

\*Adjusting the Aux Send 5 to 0 adds the Input Channel 1 to the Sub Group.

3. Repeat Step 2 for all the input channels that are part of the Sub Group.
4. The channel faders Aux Master (Aux 5) now functions as a Sub Group Master.

## Matrix Mixing

To understand a matrix, it's first useful to understand the concept of a sub-mix (sometimes called a "stem"). As the name implies, a sub-mix is a mix consisting of some subset of all the mixer's inputs. For example there could be sub-mixes consisting of all the violins, or the choir, or drums, or delegate microphones or sound effects. If you've got all of these at once you've got a really interesting production but we digress. A matrix simply lets you blend these sub-mixes (stems) into a single mix.

A stem can be created by assigning inputs to a Sub-Group or by sending them to an Auxiliary. Now that we've got the stems, what do we do with them? On the TouchMix-30 Pro, Auxiliaries 9 – 14 also function as mix matrices. In addition to all the input channels, these signals may be sent to Auxiliaries 9 – 14...

- Main L/R
- Auxiliaries 1 – 8
- Sub-Groups 1 – 8

All of these stems can be mixed as needed and routed out via Auxiliaries 9 – 14. The application may be as simple as just sending a mono mix of the Main L/R to an overflow area or as complex as creating a separate broadcast mix from 8 or more stems. In addition, all the inputs are available on Auxiliaries 9 – 14 so it's possible to mix in the signal from one or more input channels.

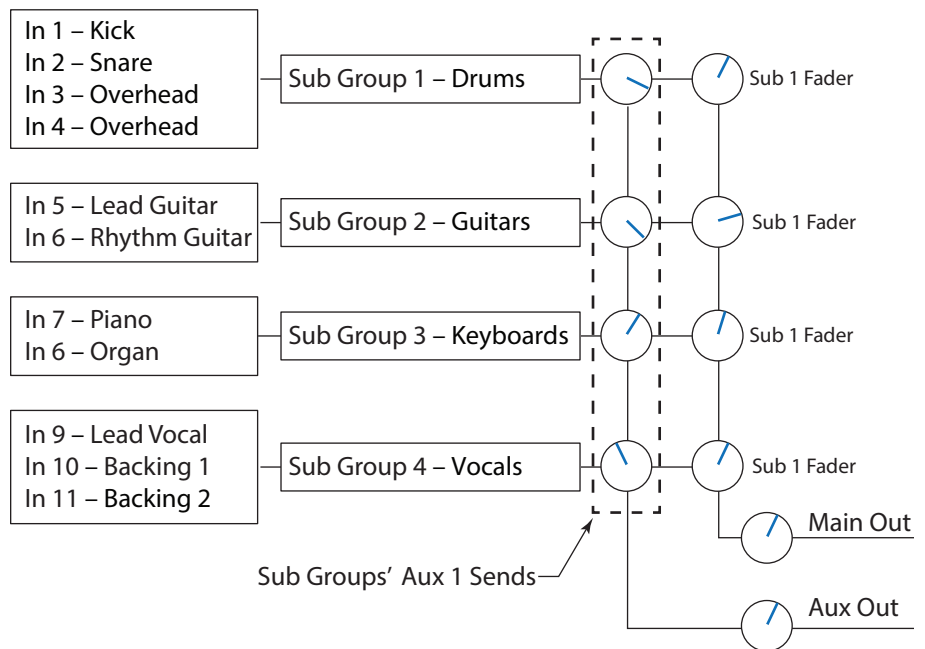



## Save Your Work as a Scene

You've put some effort into setting up your mix so now would be a great time to save it. A Scene is a snapshot of all the settings on the mixer.



**TIP:** It's a good idea to save your scene with the outputs muted or levels down. Why? Because it's possible that the gain settings on power amplifiers or powered loudspeakers have changed since the scene was saved. Recalling the scene could result in a blast of feedback from all the speakers connected to the mixer.

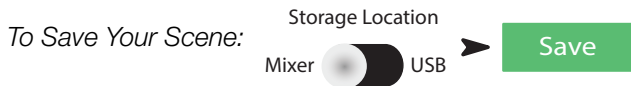

## Sound Check

Before connecting anything, plug in your TouchMix and make sure that all the inputs and Auxiliary Outputs are muted. This will prevent uncontrolled feedback if a microphone is patched into a hot channel.

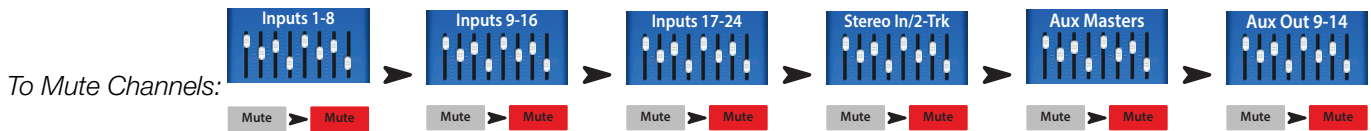

In each of the groups of faders, press the Mute button for each channel. Now you can connect the mixer to sources and speaker systems.

## Using TouchMix with QSC Amplifiers and Loudspeakers

If you're using QSC **E, K, K.2, KW** or **KLA** loudspeakers or **GXD** amplifiers your TouchMix can recommend input level settings to help optimize your system gain structure as well as offering output presets for different applications.



## Loudspeaker Gain and Preset Pop-up

In addition to displaying the recommended input gain setting (1) for the selected loudspeaker (2), the pop-up displays a choice of presets (3) for the loudspeaker. For most QSC loudspeaker there are options that optimize the loudspeaker for live sound reinforcement, stage monitor use or dance music playback.

In the pop-up all you need to do is:

1. Touch the button associated with your loudspeaker, or amplifier
2. Adjust your equipment as instructed
3. Select the preset you want to use with your loudspeakers
4. Touch Recall Preset.

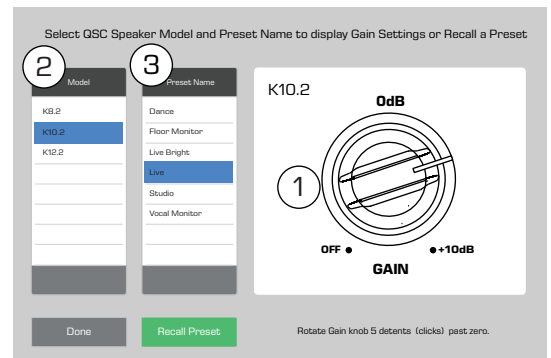

These settings give you the optimum signal to noise performance and get the most from your QSC loudspeakers or amplifier. The mixer's output meters will reflect when you're "running out of speaker". Note that you will see the "Limit" light on your speakers illuminate as the mixer drives them harder during louder portions. This is normal and is just the speaker's internal DSP doing its job.

## Select a QSC Loudspeaker Preset

The GXD amplifier and K.2 Series loudspeakers both have presets for various applications. The TouchMix mixers have the same presets. Make sure you use only one or the other. Do not use the TouchMix presets if you have presets set up in the GXD or the K.2 loudspeakers, and vice versa.

**E-Series** – QSC's GXD series amplifiers include voices for QSC E-Series loudspeakers. If you are using any other amplifier, E-Series voices may be applied by the TouchMix. Be certain that any equalization in the amplifiers you are using is bypassed or set to flat.

**K.2 Series** – The K.2 presets may also be recalled from the channel Preset screen. These settings are identical to those available from the Gain and Preset Pop-up. These are identical to the factory presets in the K.2 loudspeakers. Simply set your K.2 speakers to the factory default setting and leave it there. The mixer will now supply the preset.

To recall a Loudspeaker Preset:



## QSC GXD Amplifier Settings

If you are using a QSC GXD amplifier, you can optimize the gain and sensitivity for use with your TouchMix. [See "GXD Amp Settings" on page 59](#)

## Phantom Power (+48V)

Most condenser microphones and some direct boxes require phantom power from the mixer. On TouchMix mixers, phantom power may be turned on or off on a per channel basis. Make sure that phantom power is on for those channels that need it and off for those that don't. It's a good practice to keep Phantom Power turned off when making connections in order to avoid the inevitable loud pops that will occur.

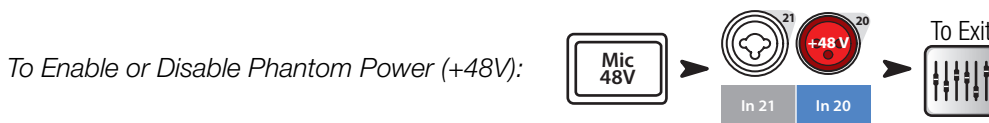

Phantom power is also accessible from the channel Setup screens.

## Work on Your Inputs

Ask the performers in turn to do what they do to make their audio contribution to the performance. Without un-muting their channels, bring the channel's input gain Trim up while watching the channel meter on the Home screen. What you are looking for is a meter that is bouncing around the 0 mark when the performer is producing a normal output level.



**TIP:** During sound check performers will usually not play as loudly as they do in an actual performance so keep this in mind and allow a little extra headroom.

With the performer performing, un-mute the channel and bring the fader up until the desired performance level is reached.

If you are using one of the internal channel presets, this channel should already be sounding good. If it's not what you're looking for, try some of the other preset choices. For most instruments and musical styles, there will be a preset that works well. If not, you'll need to dive into the channel and dial it in manually.



At the top of the screen, select the tab for the channel processing element you want to work on.

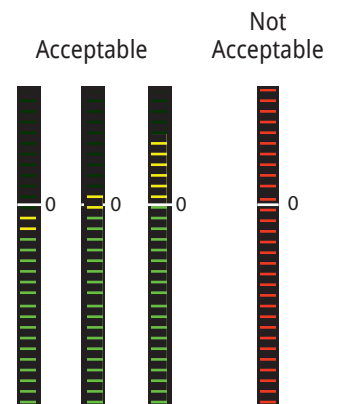

## Simple and Advanced Mode

TouchMix mixers offer two modes of operation:

- **Simple Mode** – Presents the user with a reduced set of controls. It's important to know that switching into Simple mode does not alter the values of any Advanced-mode controls.
- **Advanced Mode** – Presents all mixer controls to the user.

You can select Simple and Advanced modes individually for an EQ, Gate, Compressor or Effect. Note that the Stereo and Mono Delays do not have a Simple mode. Look for the Simple button on the screen. Or you can make the selection globally.

To Globally Select Simple / Advanced Mode: 

## Auxiliary (Stage Monitor) Mixes



There are two general approaches to setting up stage monitor mixes:

### Input by Input

With all the performers on stage, ask each performer in turn to play or sing just one thing (Kick, Snare, Guitar, Sax, etc). Ask each performer how much of that instrument they want in their monitor. Our guess is that they will all say “that’s plenty” during sound check and then ask for lots more after the first song – just sayin’.

To Set Up Monitor Mixes One Input at a Time: 

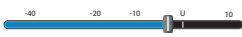
You will see sliders representing the send levels of the input to all the aux mixes. If any auxes are linked for stereo, the linked pair will have a Level control and a Pan control.

Adjust  for each performer in turn then use the  buttons to move through the channels.

### Mix On Faders

Sometimes it's preferable to set up a complete mix for one auxiliary output at a time. On the left side of the mixer's screen you will find buttons that directly access the Auxiliary mixes. Touch one of the Auxiliary Select buttons to go to the mix you want to work on. Use the faders to adjust the sends to the selected Aux Mix. Use the Nav Strip to move between fader banks.

Note that you can Mute an individual channel in an Auxiliary mix without muting it anywhere else.



**TIP:** There are times when several mixes will be similar to each other. To speed set-up, refer to ["Copy & Paste" on page 20](#).

## Output Processing

Like the input channels, the outputs (Main L/R and Aux Outputs) have their own processing.

To access Main Output Processing: 

To access Auxiliary Output Processing: 

Each output includes a full complement of processing and other functions including:

## Overview Tab

### Overview

Displays an overview of the output channel settings including Delay, DCA and Mute Group Assigns, Pre/Post pick-off points (auxiliaries only), Aux Send Levels (see Matrix Mixing).

## PEQ Tab

### PEQ

Six-band parametric EQ with High / Low-Cut filters and a Real Time Analyzer (RTA)

This tab displays the six-band, parametric equalizer plus the Low and High-Cut Filters. The 6 bands of parametric EQ can be individually bypassed using the numbered buttons. Bands 1 and 6 may be switched from parametric to shelving operation. You can use the two-finger pinch / zoom gesture to adjust the Q for the selected Band.

Touch the **RTA On** button to activate / deactivate a Real Time Analyzer display for the channel. (["Real-time Analyzer \(RTA\)" on page 102](#)).



**NOTE:** When the RTA is not enabled, the Parametric EQ screen is enlarged to occupy both the RTA and PEQ screen area.

Low-Cut / High-Cut filters – These filters are used to roll off high or low frequency content. There are a number of possible applications.

- For stage monitors, it is common to roll off low frequencies at 80 – 100 Hz. There is usually ample low frequency energy on stage without any help from the monitors. Keeping it out of the monitors can reduce “rumble” on stage and in the house.
- For speech only systems, rolling off low frequencies can reduce microphone handling noise or, if outdoors wind noise.
- Fill speakers may not need any additional low-frequency energy as there is ample bottom end coming from subwoofers.
- There is a technique known as “subs on auxes” in which the subwoofer is fed from one of the auxes while the main speakers are fed from the mixer’s main outputs. Only those instruments that contain low-frequencies are sent to the subwoofer. This provides more control over the lows and can help keep the bottom end tighter. If this is being done, the Low and High-Cut filters could be used to set the crossover point between subs and main speakers.

## GEQ Tab

### GEQ

*One-third octave graphic equalizer with an RTA*

In addition to the Real Time Analyzer (RTA), this tab displays two, overlaid 1/3 octave graphic equalizers.

- **GEQ:** The solid faders [Insert Image] control the user adjustable graphic equalizer. The “GEQ” switch may be used to bypass (Out) or activate (In) this equalizer. The “Reset” button will return the GEQ sliders to 0.
- **Tuning Wizard EQ:** If the “Tuning” switch is set to “In” a set of ‘ghost’ faders (1) is displayed to indicate the settings resulting from adjustment by the Room Tuning Wizard ([See "Room Tuning Wizard" on page 22](#)). The ‘ghost’ faders are indicators only and are not adjustable.

The GEQ and the Tuning Wizard EQ are additive. So 3 dB boost from the Tuning Wizard and a 2 dB boost from the GEQ at the same frequency will result in a 5 dB total boost.

Touch the **RTA On** button to activate / deactivate a Real Time Analyzer display for the channel. (["Real Time Analyzer \(RTA\)" on page 18](#))

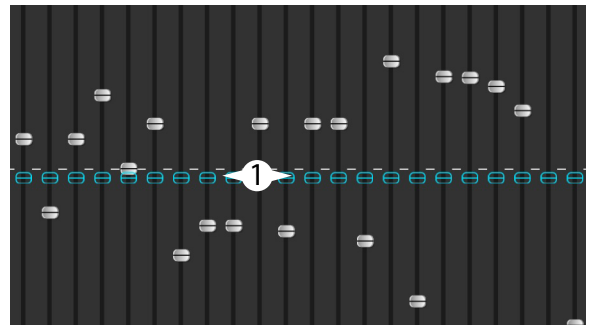

Touch the **Tuning Wizard** button to go to the Room Tuning Wizard screen.

## Anti-Feedback Tab

**Anti-Feedback**

### Anti-Feedback Wizard and Manual operation

The Anti-Feedback system automatically identifies and displays suspected feedback frequencies. When a suspected feedback frequency is identified, a single touch applies a filter at that frequency. In addition a Feedback Wizard can assist in finding and cutting feedback-prone frequencies.

## Limiter Tab

**Limiter**

Displays the limiter and its controls. We strongly encourage the use of the limiter for In Ear Monitors.

## Auxes Tab (TouchMix-30 Pro only)

**Auxes**

The Main L/R outputs may be returned to Auxiliary mixes 1 – 14. Auxiliary mixes 9 -14 may be returned to Auxiliary mixes 1 – 8. Refer to ["Patch Matrix \(TouchMix-30 Pro only\)" on page 21](#) for more information.

## Presets Tab

**Presets**

### Preset save/recall

This tab offers a Factory Preset named Reset that returns all output control parameters to their factory values. In addition, any settings you make can be stored to and recalled from either internal or external (USB) memory.

The Preset Tab also includes factory voicings for QSC E-Series and K.2 Series loudspeakers. These settings are also available for QSC PLD and GXD amplifiers. The E-Series voicings are intended for use with other amplifiers that lack DSP. An "X" suffix after the preset name indicates the preset is intended for use with a sub-woofer. Do not use the mixer presets and the PLD or GXD voicings together – your E-Series speakers will not sound twice as good.

## Setup Tab

**Setup**

The Setup Tab includes the following utility functions for the output.

Rename **Aux** Joe's Monitor Touch the field to enter a name for the output (not available on Main output).

Linking **Link** This Links odd-to-even pairs of auxiliary mixes to create a stereo mix.

### Delay

Delay is most commonly used for remote fill speakers. The objective is to set the delay so that the sound from the primary system arrives at the listeners ears just slightly (20 – 30 msec) ahead of the sound from the fill system. When done correctly, the listeners perceive the sound as coming from the primary system even though most of what they hear is from the fill speakers. In venues with very deep stages, the engineer will sometimes delay the house system so that it time aligns with the back-line. In other words, set up the system so that the sound from the

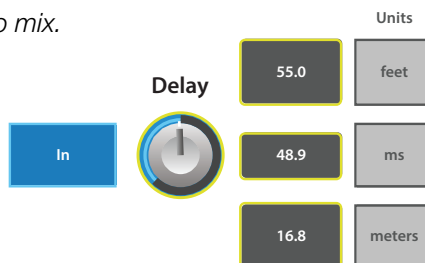



actual kick drum and the reinforced kick drum arrive at the listeners' ears at the same time. The delay provides a read out in msec. (up to 100), meters (up to 34.3) and feet (up to 113).

### Channel Safe During Scene Recall

When a Scene is recalled, it sets all the controls to the settings saved with the Scene. There may be times you do not want to change a specific output channel, or channels. The default position, Recallable, allows the scene to recall the saved settings. The Safe position does not allow the scene to change any settings of this channel.



### QSC Amplifier and Speaker Settings:



Refer to ["Using TouchMix with QSC Amplifiers and Loudspeakers" on page 9](#) and ["QSC GXD Amplifier Settings" on page 10](#). Also see ["What is a Channel Preset?" on page 2](#) for information on preset voices for QSC E-Series loudspeakers.

### Aux Pick-off



Available for the Aux mixes only, these buttons determine whether the point from which the signal is taken is before or after the channel fader. For most monitor mixing applications, this should be set to Pre Fader.

### Assignments



These buttons assign the output to a Mute Group or a DCA Group. Refer to ["Mute Groups" on page 6](#) and ["DCA Groups" on page 6](#) for details.

## Recording

TouchMix mixers make it easier than ever to capture a live performance in a stereo or a multi-track recording. All you need is a USB hard-drive.



**NOTE:** Hard-drive requirements – A list of hard-drives that QSC has qualified may be found at [qsc.com](http://qsc.com). There are far too many hard-drives available for us to test them all so there are certainly many unlisted drives that will work well with TouchMix. Higher speed drives (>7200 RPM) tend to work best. Some higher speed drives don't do their best when powered from the USB port but will work when used with an external power supply. We have also had very good luck with solid state drives. USB thumb-drives may work for recording a small number of channels but are not recommended although users report good results with better quality, USB 3.0 thumb drives.

### Formatting the drive

The drive must be formatted as FAT 32 and de-fragmentation improves seek time.

If formatting the drive from an Apple Mac computer select MS-DOS (FAT) as the Format and MBR (Master Boot Record) as the scheme.

The TouchMix mixer can also format a drive. The format function is available from the Recording Setup screen.

### Drive space for recording

Be sure that there is sufficient space on the drive for your recording. To calculate the space required for your recording...

- For 48 kHz – Space required (in MB) = 11.5 x minutes x tracks
- For 44.1 kHz – Space required (in MB) = 10.6 x minutes x tracks

It is good practice to have more disk space available than you need. If the drive is nearly full, TouchMix has to look for nooks and crannies of available space. This will result in fragmented wave files and potential loss of audio data and synchronization across tracks. At approximately 3 hours of non-stop recording, the maximum file size supported by FAT32 is exceeded. To avoid problems, stop and then resume recording. It is not necessary to create a new session. The TouchMix displays a pop-up that warns you when this limit is approaching. If you do exceed the FAT32 limit, track synchronization may be lost.



**NOTE:** Depending on the number of tracks recorded and the performance of the hard drive, multi-track playback may slow down the rendering of objects on the mixer screen resulting in lagging display of control movement.

## Transferring tracks between TouchMix and DAW

A utility application – TouchMix DAW Utility - that facilitates transferring tracks between TouchMix mixers and Digital Audio Workstations is available for download at [www.qsc.com](http://www.qsc.com). The application runs on Mac or Windows computers.

### Sample Rate

In general, use 44.1 kHz for CD projects, and 48 kHz for video projects. Do not change sample rate while recording.

To View or Change Sample Rate: 

### Multi-Track Recording

All TouchMix models are capable of recording all audio inputs plus a stereo mix directly to a USB hard-drive (see above). The audio is captured as a 32-bit, floating point wave file.

### Recording and Playback Capacity

- TouchMix-30 Pro: 32 tracks (30 inputs + stereo mix)
- TouchMix-16: 22 tracks (20 inputs + stereo mix)
- TouchMix-8: 14 tracks (12 inputs + stereo mix)

Connect a hard-drive (see above) to one of the USB inputs of the mixer.

Set the External Recording & Playback Mode to Multitrack: 

To create a recording session: 

To select channels to record: 

Touch  for each channel you want to record.

Once all the channels you wish to record have been armed, touch (Record Button) to begin recording. Touch the (Stop) button to end recording.



**NOTE:** User buttons may be assigned to Arm / Disarm and select Track or Input as the source for all channels at once. "[User Buttons](#)" on page 24



**IMPORTANT:** Do not unplug your TouchMix until you have stopped recording! If you do, your recorded tracks will not be usable. You must end the Session by touching the STOP button on the transport control. Doing so writes a header file that is needed in order to play back the recording or import it into a DAW.

The TouchMix mixers permit over-dubs, however only the last recorded track will play back on the mixer. Earlier passes are left on the drive and may be imported into a DAW.

## Multi-Track Playback & Mix Down

Tracks recorded on the TouchMix mixers may be played back and mixed down on the mixer.



A list of available recordings is displayed. Select the recording you want to play and touch Recall. Now that the session is loaded, the next step is to switch the input channel source to "Track".

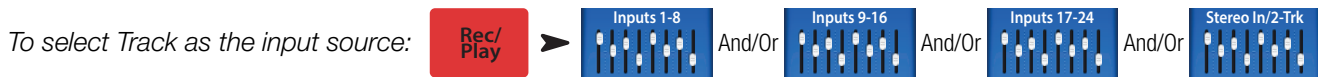

Touch **Track** for each channel you want to play back.

Use the Locator bar at the bottom of the Rec / Play screen to set the starting point for recording.

## Mix Down

There are three ways to mix down your multi-track recording.

- Import the multi-track waves into a DAW (digital audio workstation). See "Transferring Tracks between TouchMix and DAW" above.
- Record the mixer's analog output to an external 2-track recorder. Simply connect the TouchMix Main L/R outputs to the inputs of your 2-track device.
- Record a stereo mix to DAW via the USB DAW connection (TouchMix-30 Pro only).
- Internal mix down to 2-track.

To mix down to 2-track:

1. Recall the session and set up the mixer for Playback as described above.



If you would like to use the Main L/R channel processing on the stereo mix, select **Post**, if not, select **Pre**. Touch **Arm**.

Return to the Rec / Play screen and touch to begin mix down. When you are finished, touch on the transport controls.

What to do with the 2-track mix down?

- Export to a DAW for further processing and to be edited into individual songs. The wave files may be found in the last two folders of the directory containing the session.
- TouchMix-30 Pro only – Create an MP3 version from the mixer. The TouchMix-30 Pro has the capability of rendering the 2-track mix as an MP3 file.



The MP3 audio file will be saved to the "\<session name>.tmRecord\exports" directory.

## DAW Interface

The TouchMix-30 Pro is capable of interfacing to Mac OSX computers with Core Audio. Core Audio was introduced with OSX version 10.3. The mixer must be connected to the computer using a USB type-B connector attached to the "USB DAW" port of the mixer. To verify that your Mac is connected, open the Audio MIDI Setup utility on the computer (Finder > Applications > Utilities > Audio MIDI Setup). "QSC TM30 Pro" will appear in the Audio Devices window. Select the mixer and make sure that the sample rate on the Mac matches that of the Mixer.



Your DAW software will also likely require some configuration to connect with the TouchMix-30 Pro. See your DAW software documentation for information on this topic. There is also a guide to configuration of some common DAW software at [www.qsc.com](http://www.qsc.com).



**NOTE:** User buttons may be assigned to Arm / Disarm and select Track or Input as the source for all channels at once. "[User Buttons](#)" on page 24

## Anti-Feedback System

The TouchMix-30 Pro includes twelve narrow-band, anti-feedback filters on each output (eight filters for TouchMix-8 and TouchMix-16). These filters are extremely useful for eliminating feedback frequencies while having very little effect on overall tonal balance. The filters may be adjusted manually or automatically using the "Feedback Wizard" (see below).

### Manually Ringing Out a System

In order to identify feedback frequencies, it's necessary to deliberately make the system feedback. This process is known as "ringing out" or "squeaking" the system. Here's how an experienced sound system operator would go about it.

- Bring all mixer output faders to minimum
- Place all microphones and speakers in position
- Bring the input level of power amplifiers or powered speakers to the level that will be used in performance.
- Bring the input gain and channel faders for the mix you're working on to the approximate level they will be at during the performance.
- Warn anybody who is around that you are going to make some unpleasant noises.
- Slowly and carefully bring up the fader for the output you are working on until the system begins to feedback.
  - Be prepared to quickly back down the fader if the feedback really starts "taking off".
  - It may be necessary to have someone talk or shout into a microphone to "excite" the system into feedback.
- Adjust the frequency of a filter to match the feedback frequency and reduce the gain until the feedback goes away.
- Repeat until you have achieved sufficient system gain without feedback.

### Using the Feedback Wizard

The tricky part is to identify the feedback frequencies. Fortunately, you don't need to identify them because your TouchMix has built-in tools to do that for you. Here's how to use those tools.

*To access the Anti-Feedback System:*



### Pre-Feedback Wizard Checklist:

- Microphones and loudspeakers in their performance positions.
- Input channel gain and level settings approximately at performance levels.
- Zero the filter bands or touch Reset. The Wizard won't use a filter unless its gain is set to 0.0 dB Cut.
- Output you're working with set at a level that's slightly below its threshold of feedback.
- If the space is very quiet, turn on some noise using the control in the Feedback Wizard.
- The Wizard will cause feedback to occur briefly at levels that may be uncomfortable to those who are sensitive to such things. Let them know it's coming.

Follow the step-by-step instructions on the screen. The Feedback Wizard gradually brings up the Master Fader. As it does, feedback ring frequencies will emerge. The Feedback Wizard will identify the frequency and automatically apply a notch filter. You may continue the process until the Feedback Wizard has used up all Anti-Feedback Filters or you may touch "Done" or "Anti-Feedback Wizard" at any point. Typically, eliminating five or six feedback frequencies should be sufficient.

## Licensed to Kill Feedback

The Feedback Wizard algorithm is looking for suspected feedback frequencies even when the Wizard isn't active. The most recently identified suspect frequency is displayed in the "Feedback Frequency" window. Simply touch the  button and an Anti-Feedback Filter will be applied to the frequency.

## Lingering Feedback Problems

If you have used the Wizard or Manual Kill function to apply all anti-feedback filters and your system is still unstable (prone to feedback) there are several other possibilities...

- Improper microphone selection or placement.
- Improper microphone technique.
  - The performer is cupping the head of the microphone because he's seen the cool guys on videos do it. This actually turns a directional microphone into an omni-directional microphone and destroys any off-axis feedback rejection the microphone has.
  - Or an inexperienced talker is holding a hand-held microphone at chest level while pacing in front of the speakers.
- Improper loudspeaker selection or placement.
- Unrealistic expectations. If you point a microphone at a loudspeaker and increase the gain enough, it will eventually feed back.
- Excessive EQ boost elsewhere in the signal chain.
- Compressor latch

## More about the Anti-Feedback System

At the bottom of the Anti-Feedback screen is a "Filter Depth" control. This can be used to vary the depth of all the Anti-Feedback Filters.

The Feedback Wizard and Manual Kill function will not readjust a filter that has already been set. They will only use an Anti-Feedback Filter that is set to 0.0 dB Cut. If all twelve filters are already in use neither function will have any effect. To make an Anti-Feedback Filter available for the Wizard or Manual Kill function, simply rotate the gain of a filter to 0.0 dB or touch the "Reset" button to zero all filters (be careful when you do this because you may be removing the filters that have been preventing feedback).

Filters are applied in the order that feedback frequencies are identified and do not correlate to the left to right arrangement of the controls. This means that Filter 1 could be applied to a high-frequency while Filter 12 is applied to a very low frequency. The filter controls and on-screen indicators are numbered and color-coded for easy identification.

There are anti-feedback systems that actively search for and filter feedback in real-time during performance and they can be quite effective for speech applications. These systems can struggle with music because it's difficult to tell the difference between unwanted sound system feedback and desired electric guitar feedback or a sustained note on an organ or synthesizer.

## Real Time Analyzer (RTA)

An audio Real Time Analyzer breaks the spectrum into frequency bands – 1/3 octave bands for the TouchMix RTA – and displays the amplitude of the signal in each band. It is useful for visualizing the frequency balance of a signal and for identifying feedback frequencies.



**TIP:** The TouchMix mixers also include a noise generator. Some may attempt to use the noise generator, output EQ and RTA to "tune" the system for "flat" response. This is an overly simplistic approach to system tuning and will rarely if ever deliver the desired results. In addition, the prolonged output of noise can stress loudspeakers and annoy others. Please see "Tuning Wizard" for a more useful approach to dialing in your rig.

The TouchMix contains two 31-band, Real Time Analyzers. These may be displayed on any combination of the mixer and tablet devices but only two RTA are available at one time. If an operator attempts to open a 3rd instance of the RTA, a confirmation prompt will appear.

One RTA (the Channel RTA) is available on all input and output EQ screens and may be displayed by touching the "RTA On" button located above the EQ / RTA window.



**NOTE:** When the RTA is not enabled, the Parametric EQ screen is enlarged to occupy both the RTA and PEQ screen area.

The second RTA (the Independent RTA) can be displayed by pushing the RTA button on the mixer or touching the RTA button on the remote control app. This RTA offers options for source selection. The user may select...

- The Main L/R signal
- The signal from any Auxiliary mix
- The Talkback microphone input
- Follow Cue (whatever is heard in the Cue bus is displayed on the RTA)



**NOTE:** The TouchMix-8 and TouchMix-16 RTA is similar in operation but only a single RTA is available.

# Mutes

The TouchMix has a sophisticated and powerful Mute system. In addition to the Mute Groups ([See "Mute Groups" on page 6](#)) inputs and individual channel sends to individual aux mixes may be muted independently.

**Main Mutes:** When a channel is muted while the Main L/R is selected, the channel is also muted to all Auxiliary and FX mixes. This is true whether the channel was muted using the channel Mute button or a Mute Group.

**Auxiliary Mutes:** It is sometimes useful to mute an individual input to only one auxiliary mix. When an Auxiliary is selected by touching one of the buttons on the left of the screen, the Mute button that is displayed with the channel faders will effect only the selected auxiliary mix.

The Mute buttons have three states...

- **Mute** : *Indicates the channel is not muted.*
- **Mute** :
  - » *With Main L/R mix selected, indicates that the channel has been muted by pressing the channel Mute button. The channel's signal is also muted for all auxiliary sends.*
  - » *With Auxiliary mix selected, indicates that the channel is muted for the currently selected Auxiliary mix. This affects only the muted channel and only for the selected Aux mix.*
- **Mute** :
  - This is an indication that the channel is muted by something other than the Mute button you're seeing.*
  - » *With Main L/R mix selected, indicates that the channel is muted from a Mute Group, or DCA Group\*.*
  - » *With Auxiliary mix selected, indicates that the channel is muted from a Mute Group, DCA Group or at the Main L/R mix.*
  - » *For FX Returns, indicates that the channel is muted from a Mute Group, DCA Group or FX Mute button*



**NOTE:** \*A DCA mute will not mute an auxiliary send that is set to a pre-fader pick-off point.

## Copy & Paste

The TouchMix-30 Pro has a powerful but simple copy and paste function that is operated by the U7 (copy) and U8 (paste) buttons (U2 and U3 on the TouchMix-8 and TouchMix-16). Copy and Paste is context sensitive so that what you are looking at is what will be copied. Only like things may be copied and pasted from and to each other. For example, a PEQ cannot be pasted to a GEQ. The table below explains what parameters will be copied and pasted.



**NOTE:** The copy buffer retains the last item of each type that has been copied. If, for example a GEQ setting is copied and then a Gate is copied, both will reside in memory. If a GEQ is displayed, Paste will recall the copied GEQ parameters. If a Gate is displayed, Gate parameters will be pasted.



The example above shows the mix that's on Auxiliary 1 copied to Auxiliary 5.

After set-up is complete, it may be useful to clear the Copy/Paste buffer. This will prevent accidentally pasting parameters during the show. To clear the Copy/Paste memory:



What's Displayed	What will be copied & pasted
Main or Auxiliary Faders View	Fader and Pan
Input Channel Overview Tab	EQ, Compressor, Gate, FX sends, Aux Sends, Digital Gain, Delay, Group Assigns, Polarity
Input Channel EQ Tab	All channel EQ parameters
Input Channel Comp Tab	All channel Compressor parameters
Input Channel Gate Tab	All channel Gate parameters
Input Channel FX Tab	All channel FX send levels
Input Channel Aux Tab	All channel Auxiliary Send levels and Pan positions
Input Channel Setup Tab	Recording Arm, Polarity, Delay, Digital Gain, Group assignments
Output Channel Overview Tab	PEQ, Limiter, FX sends, Aux Sends, Delay, Group Assigns, Polarity, Pick-Off Point (Auxes only)
Output Channel PEQ Tab	All channel PEQ parameters
Output Channel GEQ Tab	All channel GEQ parameters
Output Channel Anti-Feedback Tab	All channel Anti-feedback parameters
Output Channel Limiter Tab	All channel Limiter parameters
Output Channel FX Tab	All channel FX send levels
Output Channel Aux Tab	All channel Auxiliary Send levels and Pan positions
Output Channel Setup Tab	Recording Arm, Polarity, Delay, Digital Gain, Group assignments
FX Channel Overview Tab	Current Preset, EQ, Pick-Off Point, Group Assigns, Polarity
FX Channel EQ Tab	All FX channel EQ parameters
FX Channel Preset Tab	Processor and Preset selection, FX Returns and Pans to Aux
FX Channel Aux Tab	All FX Channel Auxiliary Send levels and Pan positions
Sub Group Overview Tab	PEQ, Limiter, FX sends, Aux Sends, Group Assigns
Sub Group EQ Tab	All Sub Group PEQ parameters
Sub Group Limiter Tab	All Sub Group Limiter parameters
Sub Group FX Tab	All Sub Group FX send levels
Sub Group Aux Tab	All Sub Group Auxiliary Send levels and Pan positions

## Patch Matrix (TouchMix-30 Pro only)

The Patch Matrix is a powerful tool but it is also one that can create problems. Make sure you clearly understand this function before attempting to use it.

The TouchMix-30 Pro has audio inputs plus a set of graphical controls and processing for each audio channel. Let's call these "Inputs" and "Channels". By default, the audio for Input 1 is controlled and processed by Channel 1, Input 2 is controlled and processed by Channel 2 and... well you get the idea.

There are occasions when it is useful to route an Input to an alternate Channel. Before you do, there are a few things to understand.

- The Patch Matrix only effects the digital audio signal. So rerouting Input 1 to Channel 6 does not change the fact that input gain trim still has to be set using the Trim 1 control.
- Unless you keep track of the changes you've made, altering the default patching can make signal tracing confusing. You know the microphone is connected to Input 1 but why isn't there any signal showing up on Channel 1?





That said, there are some reasons to use the Patch Matrix. The first is simply to rearrange the order in which inputs appear on the controls. Before making a change on the Patch Matrix, ask yourself if it wouldn't be easier and potentially less confusing to physically re-patch the input. If the answer is no, here's how to proceed.

To access the Patch Matrix: 



**NOTE:** When the Patch Matrix is loaded for the first time after the mixer was powered on, it may take a few moments to display. The Patch Matrix displays the Analog Inputs across the top of the screen and the Destination Channels down the right side. Connection is indicated with lines and a blue circle.

To change a connection:

- Touch the button of the  you want to re-patch. The button changes .
- Touch the Channel  where you want to route the input.
  - » The Channel changes to , the lines and blue circle move to indicate the new routing.
- To route the input to a second Channel, touch  of the second Channel to which you want to route the input.
- If you make a mistake in selecting a Channel, simply touch it again to restore the previous routing.
- Touch the input button to complete the re-patch.



**TIP:** Why would one want to route the same input to two Channels? This is known as "Multing". The term comes from old-school analog patch bays that had some jacks wired so that a single signal could be patched to multiple destinations. Here's an example of how it's used. Let's say you've got an acoustic guitar on stage and you've dialed it in for the main speaker system. But no matter what you do, you can't get it to sound right in the monitors without compromising the sound the audience hears. You could use an XLR Y-Cable to patch the guitar into two mixer channels, or you could use the Patch Matrix to mult the guitar to a second Channel. Send that channel only to the performer's stage monitor and adjust as needed to make our demanding guitarist happy.

To reset the Patch Matrix to default routing: 

Patch Matrix settings may also be saved and recalled using the  button.



# Room Tuning Wizard

The Tuning Wizard assists the operator in adjusting an output equalizer to compensate for variations in room acoustics and loudspeaker response. The three TouchMix models handle measurement microphone connection in slightly differing ways.

## TouchMix-30 Pro

The measurement microphone is connected to the Talkback input and is controlled entirely from within the Room Tuning Wizard.

## TouchMix-8 or TouchMix-16

For these mixers the microphone is connected to input 8 (TouchMix-8) or input 16 (TouchMix-16). When the Room Tuning Wizard is opened, channel 8 (or 16) is automatically muted and its input signal is routed to the Room Tuning Wizard. The measurement microphone may then be connected to input 8 (or 16) and the Room Tuning process may be run. Upon completion, the input channel is muted to allow disconnection of the measurement microphone and re-connection of the instrument previously connected. The input 8 (or 16) channel mute can then be lifted by the operator. The Room Tuning Wizard has no effect on the input channel settings.

Before proceeding with the Tuning Wizard, listen to your system in the room using material with which you are familiar. Many contemporary loudspeaker systems – especially powered loudspeakers such as the QSC K.2, K, KW and KLA series – have been carefully tuned by design and will sound very good with little or no additional equalization.

That said, here's how to use the Room Tuning Wizard. Before you begin, you will need a measurement microphone with flat response, a microphone stand and a microphone cable that's long enough to reach from the mixer to the coverage area of the speakers being measured.

When using the Room Tuning Wizard, it's best to do so before applying any of the output channel's parametric EQ or Anti-Feedback filters.



OR



3. Select an output to tune 

4. Select a measurement method.  OR  OR  OR 

 **NOTE:** The *Low Precision* method uses just a single measurement while the *Medium* and *High Precision* methods require multiple measurements and repositioning of the microphone. The *Skip Measurement* method will retain the results of the last measurement but allow selection of one of the other target tuning curves that we'll discuss in a moment.

5. Touch . The wizard displays instructions and a guide to microphone placement.

 **NOTE:** Most measurement microphones are condenser microphones and require phantom power which may be switched on from the Room Tuning Wizard screen.

6. Enable  if needed.

7. Touch .

8. Follow the directions and adjust the  so that the RTA displays a moderate level of activity.

9. Touch **Measure**. The mixer produces the test signal and captures the measurement data.



**NOTE:** Each output of a TouchMix mixer actually has two graphic equalizers. One is used by the Tuning Wizard to apply corrections based on the measurement data. Settings for this equalizer are indicated by the outlined or “ghost” fader caps on the GEQ screen. The other equalizer may be adjusted by the user.

10. Select a target tuning.

» Select **Flat** – The wizard flattens the system response using the Tuning EQ and sets the user EQ to flat. You can adjust to taste from there.

» Select **Live** – The wizard flattens the system response and applies a User EQ setting that works well for live sound reinforcement systems.

» Select **Keep Existing** – The wizard flattens the system response using the Tuning EQ but leaves the user EQ settings untouched.

11. Touch **Restart** if the measurement is interrupted by, for example, unexpected, loud ambient noise. Perform the measurement again.









12. Touch **Finish** to continue.

13. Touch **Navigate To GEQ** to view the GEQ settings.

# User Buttons

The TouchMix-30 Pro has eight user-assignable buttons (U1 – U8) while the TouchMix-8 and TouchMix-16 have four (U1 – U4). The remote control apps for all models provide 8 user buttons. The following are assigned by default:

## TouchMix-30 Pro

-  – *Navigate Left (moves the selection left)*
-  – *Clear Clip (clears clipping indication from the Navigation Strip)*
-  – *Clear Cue (clears all cue selections)*
-  – *Navigate Right (moves the selection right)*
-  – *Play/Stop (starts or stops playback)*
-  – *Rec/Stop (starts or stops recording)*
-  – *Copy (see Copy & Paste)*
-  – *Paste (see Copy & Paste)*

## TouchMix-8 / TouchMix-16

-  – *Navigate Left (moves the selection left)*
-  – *Copy (see Copy & Paste)*
-  – *Paste (see Copy & Paste)*
-  – *Navigate Right (moves the selection right)*
-  – *Play/Stop (Tablet app only)*
-  – *Rec/Stop (Tablet app only)*
-  – *Clear Clip (Tablet app only)*
-  – *Clear Cue (Tablet app only)*

The User Buttons may be reprogrammed to suit your preferences.



**NOTE:** The Name displays on the tablet app User Buttons.



Touch the  button to restore the default assignments.



**TIP:** For instant navigation to a particular screen, there's a simple shortcut method to program a User Button. Let's say that you want to be able to get to the input channel overview of the lead singer's channel (channel 12) quickly. Simply navigate to the Channel 12 Overview tab and hold a User Button for two seconds. Touch "Yes" and the User Button will now take you to the Channel 12 Overview screen no matter where you are.

# MIDI Control

A USB-over-MIDI device such as a foot switch may be used to control some TouchMix-30 Pro functions. MIDI Control is similar in function to User Buttons.

1. To program MIDI Control: 
2. With a compatible MIDI device connected to the mixer, touch  .
3. Send a MIDI command to the mixer and that command will now be associated with the selected MIDI button.
4. To assign a function to the "learned" button: 

# Security

The TouchMix mixers have multi-level security that allows you to assign passwords to various levels of functionality. You can give users access to only the functions they are authorized to use.



**IMPORTANT:** Leaving a password field empty allows anyone to access the associated functions without any log-in. The Security Setup menu offers four levels of access:

- **Administrator:**  
Logging in as Administrator gives access to all mixer functions including Security Settings. If the mixer is accessible to others, it may be a good idea to enter an administrator password to prevent mischievous or inadvertent password creation that would lock you out of your own mixer. Be certain you can remember this password!
- **All Access:**
  - *No password:* Anyone can access all functions other than Security Setup.
  - *Password protected:* Access to Advanced functions requires password log-in.
- **Simple Mode Only:**
  - *No password:* Anyone can access all functions (other than Security Setup) in Simple Mode only.
  - *Password protected:* Access to all Simple Mode functions requires log-in.
- **Levels Only:**  
In order to password protect the mixer from any unauthorized adjustment, create a password for this level.
  - *No password:* Anyone can adjust level controls only.
  - *Password protected:* Access to level controls requires log-in.

Further restriction can be placed on each access level.

- **Overwrite Scenes & Presets:** Allows or denies the ability to change a Scene or Preset in user memory.
- **Recall Scenes:** Allows or denies the ability to recall a scene from memory.
- **Recall Presets:** Allows or denies the ability to recall a preset from memory.
- **Auto-lock:** Sets a timer that automatically logs out after a preset period (up to 25 hours) with no activity at the mixer controls.



## Monitor (TouchMix-30 Pro only)

The monitor output is most commonly used to feed a pair of monitor loudspeakers.

To adjust Monitor level:  Use the Master Rotary Encoder.

The monitor pop-up includes the following controls:

- **Source Selector** – Selects a signal for the Monitor output.
  - » *Aux 1 through 14* – The monitor output signal is derived from the selected Aux mix.
  - » *Main LR* – The monitor output signal is derived from the Main L/R output.
  - » *Cue* – The monitor output follows the Cue selection.
- *In* – Engages / bypasses the delay.
- **Delay** – The delay is used to align the audio coming from a distant stage with the near-field monitor signal heard at the mixer position. Digital readouts are in feet, milliseconds, and meters.

Touch  or push  to close the pop-up.

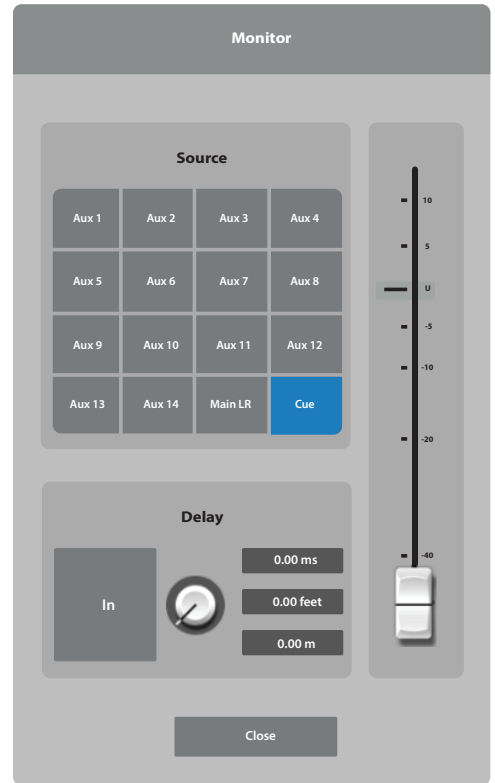

## Monitor (TouchMix-16 only)

Controls the output level for the Monitor Cue

To adjust Monitor level:  Use the Master Rotary Encoder.

**Monitor / Cue Level** – Controls the level of the Cue signal on the Monitor outputs.



**NOTE:** By default, no audio signal is sent to the Monitor Outputs. To send audio channel signals (including Main LR) to the Monitor Outputs, enable the Cue button for the channels you want to listen to.

Touch  or push  to close the pop-up.

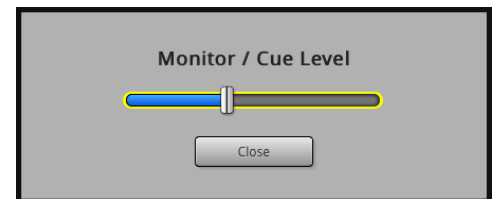

## Solo In Place (SIP) (TouchMix-30 Pro only)

When setting up a sound system, it can be very useful to mute all the inputs except for the one being worked on. This could be accomplished by manually muting all the other channels but there's a more convenient way.

To set up Solo In Place:   

When Solo In Place is engaged, the input channels' Cue buttons change color to light red and are labeled SIP. Touching a channel's SIP button will mute all the other input channels and the SIP button turns solid green. Multiple inputs may be soloed. The Cue system functions normally for the mixer's outputs.

The Solo In Place function does not affect FX returns. This means that when an input channel is soloed, any effect routed to that channel will still be heard in the mix. If it is desirable to hear a channel soloed without effects, the FX Mute button may be used to mute all effects independently.



**IMPORTANT:** Solo In Place (SIP) is an extremely useful function for setup and troubleshooting but can be hazardous during a show. Be certain to disengage Solo In Place when setup is complete.

# TouchMix Reference

The information provided in this section gives you a detailed description of the screens and controls for the TouchMix-30 Pro and the TouchMix-30 Pro remote apps. The screen shots provided are taken from the TouchMix-30 Pro iPad App, and because of a different screen size, may appear slightly different than the TouchMix-30 Pro screens. The topics are in the order of the Info menu buttons on the mixer.

## Getting Started

### Top Panel and Remote-Device Controls (TouchMix-30 Pro)

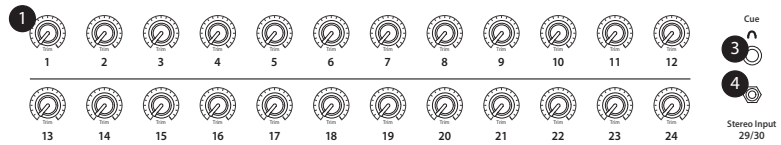

- Trim knobs** — Channels 1 – 24 adjusts analog input signal level prior to A/D conversion.
- Color LCD touchscreen**
- Cue headphone jack** — 1/4" stereo headphone jack. The output is controlled by clicking the Cue button on a channel. Volume is controlled by pressing the **Phones** button on the front panel.
- Stereo Input 29/30 jack** – Channels 29 and 30 are permanently linked. The input is a 3.5 mm stereo phone jack.
- User buttons** — By default, these eight buttons are assigned the following functions:
  - U1** — Navigate left from the currently selected item
  - U2** — Clear clip indicators
  - U3** — Clear Cue indicators
  - U4** — Navigate right from the currently selected item
  - U5** — Play button for the currently selected Play-back file.
  - U6** — Record button starts recording audio on the selected recording setup
  - U7** — Copy the selected item
  - U8** — Paste the copied item to another item of the same type
- Wizard button** — Starts the TouchMix wizard. Choices are: FX Wizard, Tuning Wizard, Gain Wizard.
- Mic 48V button** — Opens the Phantom Power screen. Turn Phantom Power on/off and view status for all channels.
- Info button** — Opens the Info System but you already knew that or you wouldn't be reading this.
- Aux button** — Opens the Aux overview screen.
- FX Mute** — Mutes or unmutes all FX channels.
- Mute Groups** — Opens a screen where Mute groups may be controlled and edit
- Phones button** – Push to display and select the Phones / Cue level control.
- Talk button** – Momentary button that, when held down, opens the microphone connected to the Talkback mic input on the rear panel. The Talkback feature configuration is accessed from the Menu.
- Monitor button** – Push to display and select the Monitor / Cue level control.
- Home button** – Returns to the main screen with the fader bank (top navigation) and Aux (left navigation) in their selected positions.
- Menu button** – Opens the Menu screen displaying a choice of menu options, including Mixer Setup.
- Record/Play button** – Opens the record playback screen displaying controls and options.
- Anti-Feedback button** – Opens the Anti-Feedback screen for the selected output.
- RTA button** — Displays one of the mixer's two Real Time Analyzer.
- Master encoder – Not available on remote devices. Changes values or position of selected control and scrolls through lists. Press while turning to make fine adjustments.
- ø (Zero) button** — Press to move a control to its 0 (zero) position.
- Nudge buttons – Use these buttons to increment selected controls.
- Fine button** — Available only on remote tablets. Press to make the nudge button increments smaller.
- Follow Mixer button** — In this mode, the Remote Device defaults to the Overview screen of the currently selected channel. When you change channels on the mixer, the remote device follows to the new channel and displays the new channel's Overview screen. You can change to any of the other channel screens. In addition, you can select a control on the remote device and use the Master encoder knob to change the selected control.

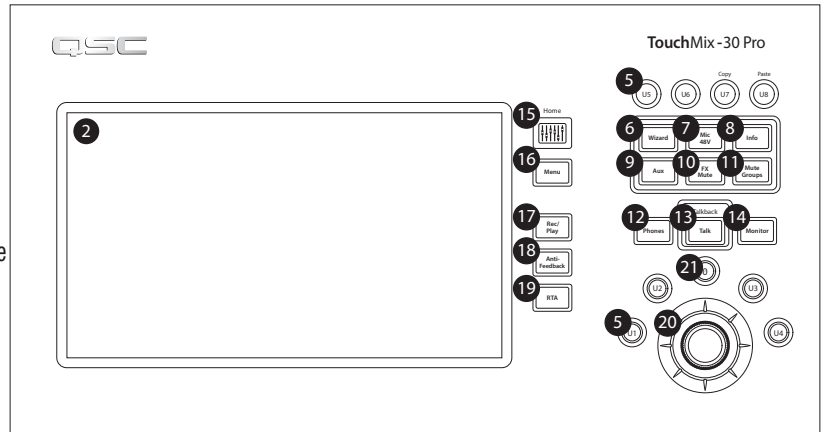

## Rear Panel (TouchMix -30 Pro)

1. **Standby** – Press to enter or exit Standby. A confirmation screen displays when entering Standby.
2. **USB** – 3.0, Type A For attaching USB storage devices<sup>1</sup>, MIDI<sup>2</sup> foot switch, Wi-Fi adapter, External Control Surfaces or upgrading the mixer firmware.
3. **USB** – Type B For attaching a Mac-based DAW. The Mac must be running OS Yosemite or later.
4. **Ethernet** – RJ45 For connecting to a network with wireless capability.
5. **AC Mains** – power connection, 100-240 V, ~85 W, 50/60 Hz



**CAUTION!** If AC power is removed, wait for 5 seconds before reapplying the AC power.

6. **Analog Inputs 1 through 20** – Balanced XLR female connectors
7. **Analog Inputs 21 through 24** – Balanced XLR / 1/4" TRS female combination connectors
8. **Stereo Inputs 25 - 30** TRS – Two female balanced linked inputs per stereo pair. Odd number is left side, even number is right side. Stereo pair 29/30 shared with 3.5 mm TRS on top panel.
9. **Cue Phones, Aux 13/14, and Aux 11/12** – Stereo female TRS 1/4" outputs
10. **K Lock® Security Slot** – Compatible with the MicroSaver Security Cable
11. **Talkback** microphone – Balanced female XLR, 48 V phantom power available
12. **Monitor Left and Right** – Balanced male XLR outputs
13. **Main Left and Right** – Balanced male XLR outputs
14. **Auxiliary outputs 1 through 14** – Balanced male XLRs

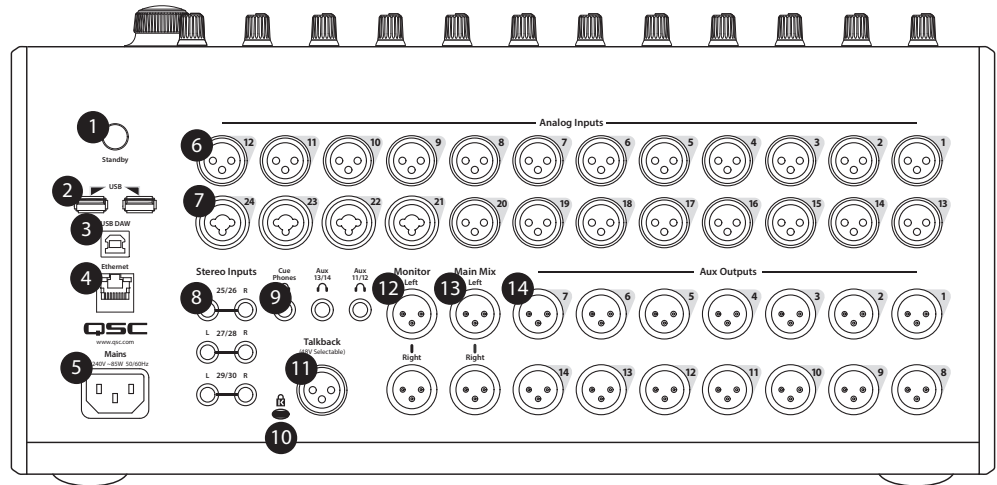

<sup>1</sup> Drives must be formatted using the FAT32 file system. A FAT32 format utility is accessible from the Recording Setup screen. For best results use 7200 RPM, USB 3 hard drives or high-speed SSD. Drive performance is critical for recording. For more information and to see a list of qualified drives, visit [qsc.com](http://qsc.com). At this time, the TouchMix-30 Pro-30 supports playback of MP3 digital audio files from the USB port, and exporting the recorded 2-Track files to the MP3 format.

<sup>2</sup> The TouchMix supports "class compliant" USB MIDI devices. QSC has verified proper operation with these USB MIDI footswitches: iCON G-BOARD and Logidy UMI3



## Left Side of the TouchMix-16 Mixing Surface

1. Rear Panel labels
2. Balanced female XLR inputs (1–12)
3. Trim – Channels 1–16 adjusts input signal level prior to A/D conversion
4. Color LCD touchscreen
5. Balanced female XLR and 1/4" TRS combo inputs (13-16). The TRS connectors supply a +10dB pad.
6. Home – Navigates up the menu structure to the Home screen
7. Menu – Displays a choice of menu options, including Mixer Setup.
8. Record/Play – Displays recording controls and options.

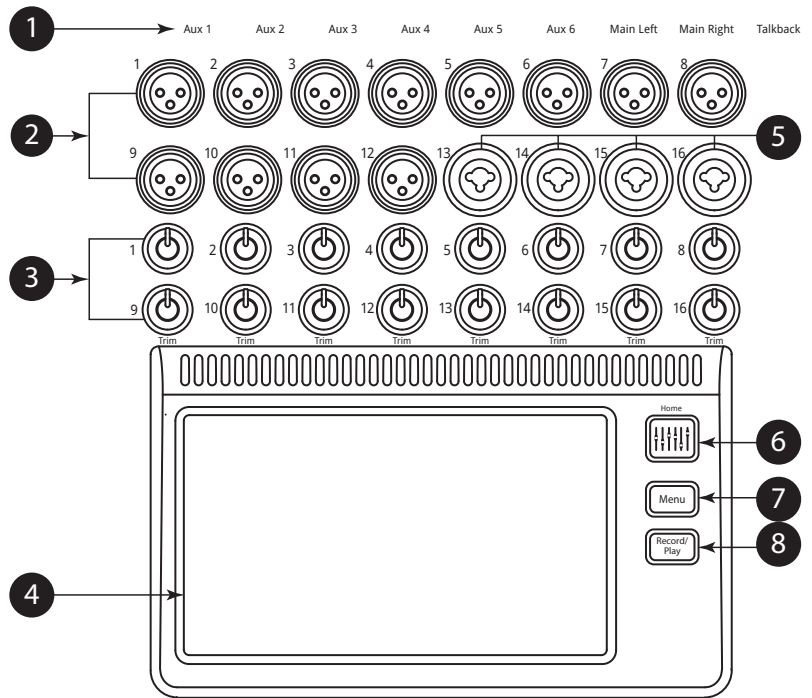

## Left Side of the TouchMix-8 Mixing Surface

1. Rear Panel labels.
2. Balanced female XLR and 1/4" TRS combo inputs (1–4). The TRS connectors supply a +10dB pad.



**NOTE:** Inputs 1 & 2 may be switched to Hi-Z for use with guitars and other instruments having passive pick-up systems. See Channel 1 or 2 Setup for more information.

3. Balanced female XLR inputs (5–8).
4. Trim – Channels 1–8 adjusts input signal level prior to A/D conversion.
5. Color LCD touchscreen
6. Home – Navigates up the menu structure to the Home screen
7. Menu – Displays a choice of menu options, including Mixer Setup.
8. Record/Play – Displays recording controls and options.

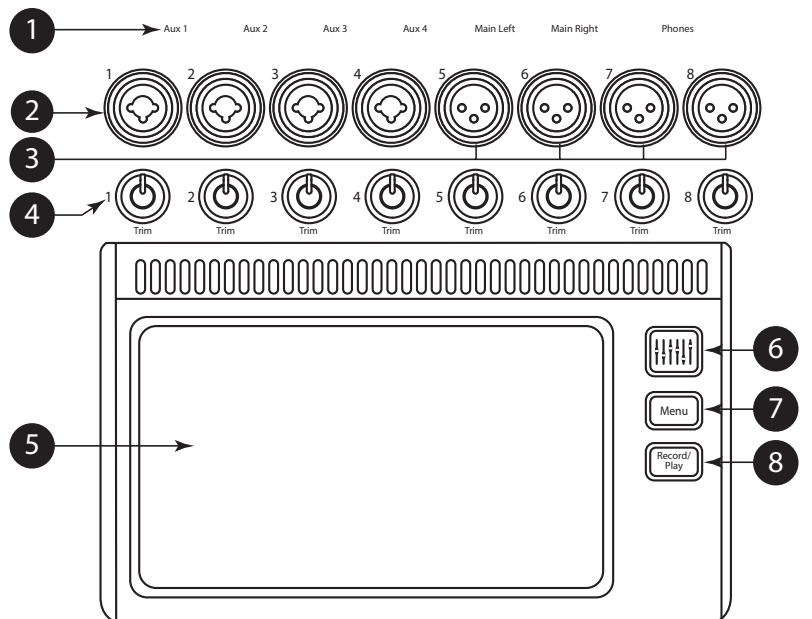



# Right Side of the TouchMix -16

## Mixing Surface

1. **1/4" TRS inputs (17/18 and 19/20)** – Line level, stereo.
2. **1/4" TRS outputs Aux (7/8 & 9/10)** – For line-level / in-ear monitors. May be configured as mono, balanced line-level outputs.
3. **1/4" TRS output Cue** – For stereo Cue headphones.
4. **Phantom +48V** – Displays input channel Phantom Power buttons.
5. **Wizard** – Links to wizards that assist with various tasks.
6. **Auxes** – A shortcut to the Aux Mix screen.
7. **1/4" TRS output Monitor** – For stereo control-room loudspeakers.
8. **Power (Standby)** – Takes the mixer in and out of Standby.



**IMPORTANT!** Before removing power (unplugging) press the **Standby** button to put the mixer in Standby.

9. **Info** – Displays the menu of help topics. In addition, you can change the language of the info system from the Info Menu.
10. **Mute Groups** – Displays Mute Group controls and setup options.
11. **FX Mute** – Mutes all four FX outputs.
12. **Phones Level** – Displays Phones level control, use Master Control to adjust.
13. **Talk** – Enables the Talkback microphone - press/hold to talk.
14. **Monitor Level** – Displays Monitor level, use Master Control to adjust.
15. **U1** – User Button – Factory default selects the next control to the left.
16. **U2** – User Button – Factory default Copy
17. **U3** – User Button – Factory default Paste
18. **U4** – User Button – Factory default selects the next control to the right.
19. **U5** – User Button – Factory default Play / Stop (remote device only)
20. **U6** – User Button – Factory default Record / Stop (remote device only)
21. **U7** – User Button – Factory default Clear Clip (remote device only)
22. **U8** – User Button – Factory default Clear Cue (remote device only)
23. **Ø** – Returns the selected control to its default position.
24. **Master Control** – Adjusts the selected parameter, press & turn for fine adjustments.

## TouchMix-16

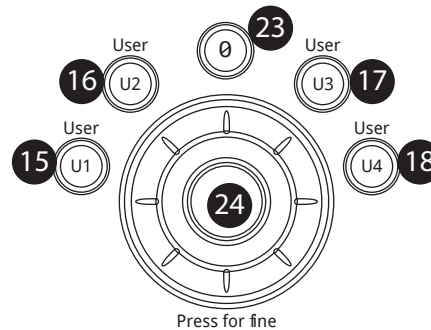
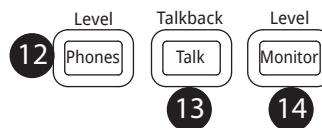
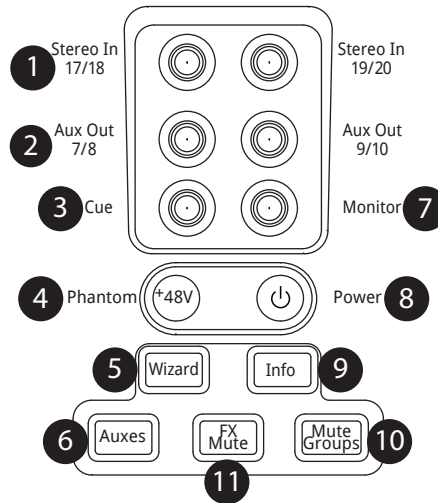

25. **Nudge (+/-)** – Increases or decreases the value setting of the currently selected parameter.
26. **Control Mode** – Changes the granularity of the Nudge control.
27. **Home** – Navigates up the menu structure to the Home screen.
28. **Menu** – Displays a choice of menu options, including Mixer Setup.
29. **Record/Play** – Displays recording controls and options.
30. **Anti-Feedback button** – Opens the Anti-Feedback screen for the selected output.
31. **RTA button** – Displays the Real Time Analyzer. There is only one instance of the RTA. It can display on the remote tablet device, or the mixer screen, not both at the same time.
32. **Follow Mixer button** – In this mode, the Remote Device defaults to the Overview screen of the currently selected channel. When you change channels on the mixer, the remote device follows to the new channel and displays the new channel's Overview screen. You can change to any of the other channel screens. In addition, you can select a control on the remote device and use the Master encoder knob to change the selected control.

## Right Side of the TouchMix -8

### Mixing Surface

1. **1/4" TRS inputs (9/10 and 11/12)** – Line level, stereo.
2. **Phantom +48V** – Displays input channel Phantom Power buttons.



**IMPORTANT!:** Before removing power (unplugging) press the **Standby** button to put the mixer in Standby.

3. **Power (Standby)** – Takes the mixer in and out of Standby.
4. **Auxes** – A shortcut to the Aux Mix screen.
5. **Wizard** – Links to wizards that assist with various tasks.
6. **Info** – Displays the menu of help topics. In addition, you can change the language of the info system from the Info Menu.
7. **Phones** – Displays Phones level control, use Master Control to adjust.
8. **Mute Groups** – Displays Mute Group controls and setup options.
9. **FX Mute** – Mutes all four FX outputs.
10. **Ø** – Returns the selected control to its default position.
11. **U1** – User Button – Factory default selects the next control to the left.
12. **U2** – User Button – Factory default Copy
13. **U3** – User Button – Factory default Paste
14. **U4** – User Button – Factory default selects the next control to the right.
15. **U5** – User Button – Factory default Play / Stop (remote device only)
16. **U6** – User Button – Factory default Record / Stop (remote device only)
17. **U7** – User Button – Factory default Clear Clip (remote device only)
18. **U8** – User Button – Factory default Clear Cue (remote device only)
19. **Master Control** – Adjusts the selected parameter, press & turn for fine adjustments.
20. **Nudge (+/-)** – Increases or decreases the value setting of the currently selected parameter.
21. **Control Mode** – Changes the granularity of the Nudge control.
22. **Home** – Navigates up the menu structure to the Home screen.

TouchMix-8

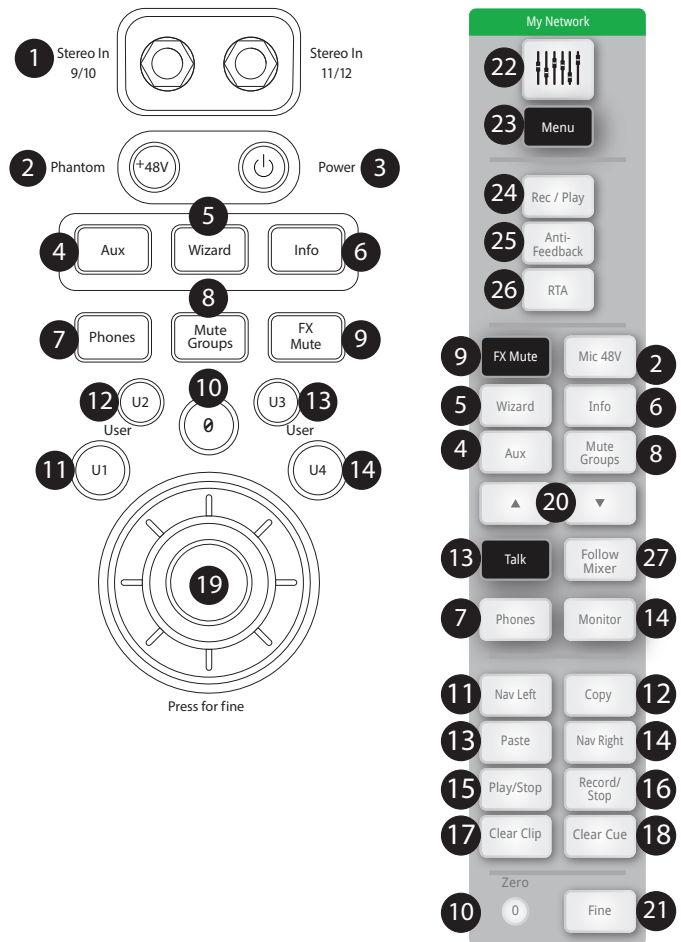

23. **Menu** – Displays a choice of menu options, including Mixer Setup.
24. **Record/Play** – Displays recording controls and options.
25. **Anti-Feedback button** – Opens the Anti-Feedback screen for the selected output.
26. **RTA button** – Displays the Real Time Analyzer. There is only one instance of the RTA. It can display on the remote tablet device, or the mixer screen, not both at the same time.
27. **Follow Mixer button** – In this mode, the Remote Device defaults to the Overview screen of the currently selected channel. When you change channels on the mixer, the remote device follows to the new channel and displays the new channel's Overview screen. You can change to any of the other channel screens. In addition, you can select a control on the remote device and use the Master encoder knob to change the selected control.

## Rear Panel (TouchMix -16)

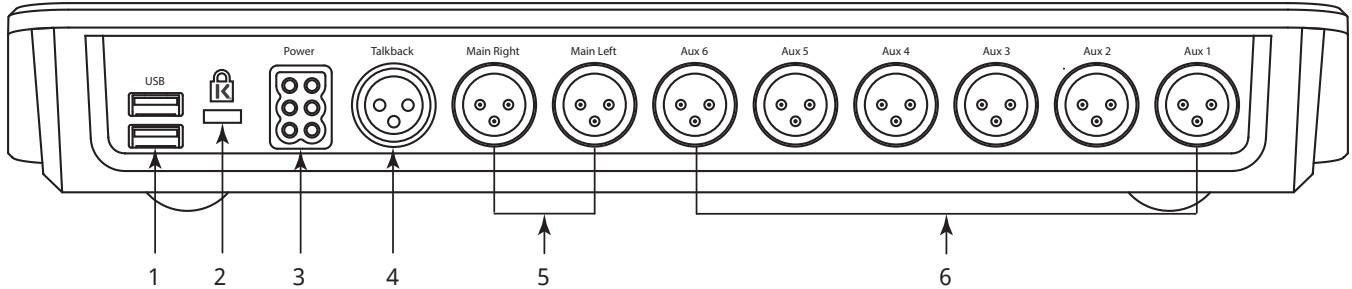

1. **USB 3.0, Type A** – For attaching USB storage devices<sup>1</sup>, MIDI<sup>2</sup> foot switch, and Wi-Fi adapter.
2. **K & Lock® Security Slot** – Compatible with the MicroSaver Security Cable
3. **Power Supply** – Use the power supply delivered with the mixer, do not substitute.
4. **Talkback microphone** – Balanced female XLR
5. **Main Right and Left output** – Balanced male XLRs
6. **Auxiliary outputs 1 through 6** – Balanced male XLRs

## Rear Panel (TouchMix -8)

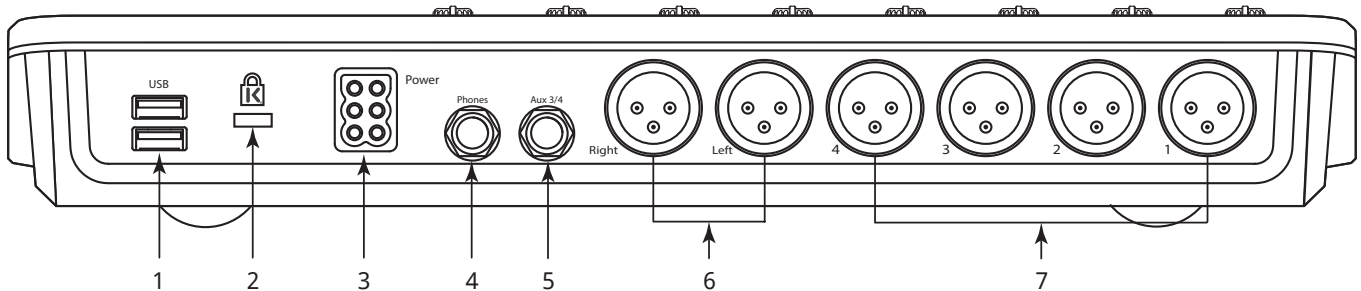

1. **USB 3.0, Type A** – For attaching USB storage devices<sup>1</sup>, MIDI<sup>2</sup> foot switch, and Wi-Fi adapter.
2. **K & Lock® Security Slot** – Compatible with the MicroSaver Security Cable
3. **Power Supply** – Use the power supply delivered with the mixer, do not substitute.
4. **Phones** – Stereo 1/4" TRS. Line or headphone output is directed to this output when a channel Cue is activated.
5. **Aux 3/4** – Stereo 1/4" TRS. Line or in-ear output. This output is wired in parallel with Aux 3 and 4 XLRs.
6. **Main Right and Left output** – Balanced male XLRs
7. **Auxiliary outputs 1 through 4** – Balanced male XLRs

1 Drives must be formatted using the FAT32 file system. For best results use 7200 RPM, USB 3 hard drives or high-speed SSD. Drive performance is critical for recording. For more information and to see a list of qualified drives, visit [qsc.com](http://qsc.com). At this time, the TouchMix does not support importing or re-importing digital audio files that have been created or edited on another device.

2 The TouchMix supports "class compliant" USB MIDI devices. QSC has verified proper operation with these USB MIDI footswitches: iCON G-BOARD and Logidy UMI3

# TouchMix -30 Pro Specifications

Parameter	Specification
Display	10" (254mm) diagonal, 1024 x 600 pixel, color TFT, capacitive multi-touch sensing
Inputs	Total 32 20 Mic/Line, XLR, 48V Phantom Power 4 Mic/Line, XLR/TRS combo, 48V Phantom Power 6 Line (1/4" TRS + 1/8" (3.5 mm) TRS top panel) USB MP3 Playback (Type A rear panel) 1 Talkback (XLR with 48 V)
Outputs	22 Total 2 Main L/R (XLR) 14 Aux Outputs (XLR) 2 In-ear Monitor (Stereo) (1/4" TRS from Auxes 11/12 and 13/14) 1 Cue (Stereo) (1/4" TRS) 2 Monitor (Stereo) (XLR)
Digital Connections	2 USB A connector, 1 USB B connector, 1 RJ-45 (connection for Wi-Fi router)
Input Channel Processing	4-band Parametric EQ with Hi/Low Shelving Option Variable 24 dB/octave HPF and LPF Gate Compressor Delay (100 msec max)
Effects (FX)	6 FX Engines Reverb Echo Delay Chorus Pitch Shift (assignable to a single mono input channel)
Output Channel Processing	1/3 Octave Graphic EQ (Main L/R, Aux 1 - 14) Parametric EQ (Main L/R, Aux 1 - 14) Notch Filters (12-bands, all outputs) 100 msec. Delay, (all outputs) Limiter (all outputs) HPF & LPF (all outputs)
Sub Group Processing	6-band PEQ HPF, LPF Compressor / Limiter
Recording/Playback	USB Direct to Hard Drive multi-track (32 x 32) DAW / Computer interface 32 x 32 channel USB audio interface to Windows and macOS computers. Stereo MP3 Playback from USB
Groups	8 DCA 8 Mute 8 Sub Groups
Cue	Selectable AFL PFL Solo in Place
Real Time Analyzer	2 x 1/3 octave 1 assigned to the selected channel 1 with user selectable source
Wizards	Anti-Feedback, Room Tuning, Gain, Effects

<b>Parameter</b>	<b>Specification</b>
Preset/Scene Memory	99 User Scenes, 143 Factory Presets 99 User Presets
External Control	TouchMix Control Apps for iPad® and Android tablets controls most mixer functions. for iOS® and Android smartphones controls personal monitor mix, rec/play, user buttons. Requirements iPad, iPhone (iOS 6 or later) / Android device (5.0 or later) Third Party Control Surfaces iCon Platform M+, Behringer XTouch Compact, PreSonus FaderPort 8
Wi-Fi	Requires: External ethernet Wi-Fi router (recommended) USB Wi-Fi adapter (QSC Part# CP-000033-00)
Sampling Frequency	Selectable 44.1 kHz or 48 kHz
THD	<0.005%, +4 dBu; 20 Hz-20 kHz, unity gain, any input to any output
Frequency Response	20 Hz-20 kHz +/-0.5 dB, any input to any output
Dynamic Range	105 dB
Equivalent Input Noise	-126 dBu
Residual Output Noise	-86 dBu
Crosstalk	-80 dB
S/N Ratio	-94 dB
Gain	Microphone inputs: 75 dB (60 dB analog, 15 dB digital)
Maximum Input Level	+16 dB (XLR mic/line inputs), +26 dB (TRS mic/line inputs), +24 dBu (TRS line inputs), 0 dBv (top panel 1/8" stereo input)
Maximum Output Level	+22 dBu (all line-level outputs)
Phantom Power	48 v, all mic and talkback inputs, individually switchable per input
Line Voltage / Input Power Requirements	100-240 VAC, 50-60 Hz
Dimensions (HWD)	Shipping: 12 in X 23.7 in X 19.5 in. (30.5 cm X 60.3 cm X 49.5 cm) Mixer only: 7.5 in X 16.9 in X 18.1 in. (19 cm X 42.9 cm X 46 cm) rack mountable with optional accessory
Weight	Shipping: 25.2 lb (11.4 kg) Mixer: 17.5 lb (7.9 kg)

# TouchMix -8 and TouchMix -16 Specifications

	<b>TouchMix-8</b>	<b>TouchMix-16</b>
Display	6.1" x 3.5" (156mm x 90mm) color TFT, touch sensing.	
Inputs (Mic/Line) <sup>1</sup>	Total 12 4 XLR / TRS combo (48V Phantom Pwr) 4 XLR (48V Phantom Pwr) 2 Stereo, TRS	Total 18 4 XLR / TRS combo (48V Phantom Pwr) 12 XLR (48V Phantom Pwr) 2 Stereo TRS
Input (Talkback)	N/A	1 XLR
Outputs <sup>1</sup>	Total 8 2 Main, XLR, line-level 4 Auxes, XLR, line-level 1 Stereo TRS Cue/Mon (Line or headphone, 16 Ω min. imp) 1 Stereo TRS, Aux 3/4 (Line / In-Ear Monitor, 16 Ω min. imp)	Total 12 2 Main, XLR, line-level 6 Auxes, XLR, line-level 2 Stereo auxes, TRS (Line / In-Ear Monitor, 16 Ω min. imp) 1 Stereo Mon, TRS (Line or headphone, 16 Ω min. imp) 1 Stereo Cue, TRS (Line or headphone, 16 Ω min. impedance)
Digital Connections	2 USB type A connectors	
Input Channel Processing	4-band parametric EQ with Hi/Low shelving option Variable 24db/octave Low-cut & High-cut filters Compressor Gate	
Effects	4 Professional effects engines configurable as: Reverb (2 types) Pitch shift Mono delay Stereo delay Chorus. Pitch Correct (One assignable to any mono input channel)	
2-Trk (USB) & FX Return Processing	2-band shelving EQ Variable 24db/octave Low-cut Compressor Gate	
Output Channel Processing	Main L/R & Aux 1 - 4 1/3 Octave Graphic EQ (GEQ) Notch Filters (8-bands) All outputs 6-band Parametric EQ (PEQ) Variable 18dB/oct Low-cut and High-cut filters Limiter/Compressor 100 msec. Delay	Main L/R & Aux 1-6: 1/3 octave graphic EQ (GEQ) Notch Filters (8-bands) All Outputs 6-band parametric EQ (PEQ) Variable 18dB/oct Low-cut and High-cut filters Limiter/Compressor 100 msec. Delay
Recording/Playback <sup>2</sup>	USB Direct to Hard Drive multi-track (14 x 14) Stereo MP3 Playback from USB	USB Direct to Hard Drive multi-track (22 x 22) Stereo MP3 Playback from USB
Groups	8 DCA groups (with mutes) 8 Mute groups	
Cue	Selectable AFL or PFL	
Real Time Analyzer	1 x 1/3 octave	
Scene and Preset Memory	100 User Scenes 100 User Presets 100 FX presets	

**TouchMix-8****TouchMix-16**

External Control <sup>3</sup>	TouchMix Control Apps for iPad® and Android tablets controls most mixer functions. for iOS® and Android smartphones controls personal monitor mix, rec/play, user buttons. Requirements iPad, iPhone (iOS 6 or later) / Android device (5.0 or later)	
Wi-Fi <sup>4</sup>	USB Wi-Fi adapter included	
Dimensions (HWD)	56 mm x 333 mm x 245 mm (2.2" x 13.1" x 9.6")	58 mm x 360 mm x 291 mm (2.3" x 14.2" x 11.5")
Weight	4.3 lb (1.95 kg)	5.9 lb (2.98 kg)
Line Voltage Requirements	100 - 240 VAC, 50 - 60 Hz	
Sampling Frequency	Selectable 44.1kHz or 48kHz	
Internal Processing	32-bit floating point	
Latency	<1.6msec, any input to any output	
THD	<0.005%, +4 dBu, 20 Hz - 20 kHz, unity gain, any input to any output	
Frequency Response	20 Hz - 20 kHz +/-0.5 dB, any input to any output	
Dynamic Range	105 dB	
Equivalent Input Noise	-126 dBu	
Residual Output Noise	-86 dBu	
Crosstalk	-80 dB	
S/N Ratio	-94 dB	
Maximum Input Level	+16 dBu (Mic/Line inputs, XLR), +26 dBu (Mic/Line inputs, TRS), +22 dBu (Stereo inputs)	
Phantom Power	48V, individually switchable per channel	
K & Lock® Security Slot <sup>5</sup>	Compatible with the MicroSaver Security Cable	
Included Accessories	USB Wi-Fi adapter, Soft Carrying Case, Power Supply	

<sup>1</sup> All TRS connectors are 1/4 inch.

<sup>2</sup> A list of drives that have been validated by QSC may be found at [qsc.com](http://qsc.com). The hard-drive market is huge and continuously changing so there are many drives QSC has not validated that will work. Always test a new drive before using it for a critical session. Minimum requirement is USB 3.0 HD, SSD or 7200 RPM, FAT32 format.

<sup>3</sup> The TouchMix App requires iOS 7 or higher.

<sup>4</sup> Use only the Wi-Fi adapter supplied with your mixer.

<sup>5</sup> Available on early production models of TouchMix-16.

# TOUCHMIX® FEATURE LIST

Alphabetical list of some of the main features on the TouchMix-30 Pro, TouchMix-8, and TouchMix-16.

Feature	Navigation	Info System Topic
2-Track Playback	Home > Stereo In/2-Trk	Two Track Playback, 2-Track Playback
2-Track Record	Home > Stereo In/2-Trk Rec	Misc Features, 2-Track Rec
Amplifier Settings	Home > Select a bank > Select an Output > Setup	Output Channels, Setup
Anti-Feedback	Select an output > Anti-Feedback	Output Channels Filters / Anti-Feedback Topic
Auto Mixer	Menu > Auto Mixer	Misc Features, Auto Mixer
Aux Mix on Faders	Select an Aux on left of screen	Misc Features, Aux Mix
Aux Mix Overview	Aux	Output Channels, Aux Overview
Channel Compressor	Home > Select a bank > Select a Channel > Comp	Input Channels, Compressor
Channel Controls	Home > Select a bank > Select a channel	Home Screen, Channel Controls
Channel EQ	Home > Select a bank > Select a Channel > EQ	Input Channels, EQ
Channel Gate	Home > Select a bank > Select a Channel > Gate	Input Channels, Gate
Channel Linking	Home > Select a bank > Select a Channel > Setup	Input Channels, Setup
Channel Overview	Home > Select a bank > Select a Channel > Overview	See "Overivew" topics
Channel Presets	Home > Select a bank > Select a Channel > Presets	Input Channels, Presets
Channel Safe	Menu > Channel Safe	Scenes / Safe
Copy & Paste	User Buttons U7 & U8	Misc. Features, Copy/Paste
Cue Mode	Menu > Mixer Setup	Misc. Features, Mixer Setup
Cue Monitor Delay (TouchMix-30 Pro only)	Monitor	Misc. Features, Mixer Setup
Cue Monitor Source (TouchMix-30 Pro only)	Monitor	Misc. Features, Mixer Setup
DAW (TouchMix-30 Pro only)	Rec/Play > Recording Mode > Multi-Track DAW	Misc. Features, DAW Interface
DCA Groups	Home > DCA Groups > Select a DCA	Misc. Features, DCA Groups
Digital Gain	Home > Select a bank > Select a Channel > Setup	Input Channels, Setup
Effects EQ	Home > Select FX Masters bank > Select an FX Channel > EQ	FX Masters, EQ
Effects Library	Home > Select FX Masters bank > Select an FX Channel > Presets	FX Masters, Presets
Effects Mix Overview	Menu > FX Overview	FX Masters
Effects Processors	Home > Select FX Masters bank > Select an FX Channel > Effect	FX Processors, sub-topics
Effects to Auxes	Home > Select FX Masters bank > Select an FX Channel > Auxes	FX Masters, Aux Sends
Effects to Auxes	Home > Select FX Masters bank > Select an FX Channel > Effect > FX Returns to Monitors	FX Masters, Aux Sends
Effects to Auxes	Select an Aux on left of screen > Select FX Masters	FX Masters, Aux Sends
FX Wizard	Wizard > FX Wizard	Wizards, FX Wizard
Gain Wizard	Wizard > Gain Wizard	Wizards, Gain Wizard
Languages	Info > Languages OR Menu > Language 中文, Deutsch, English, Français, Русский Español	No Help Topic
MIDI Control	Menu > MIDI	Misc. Features, MIDI Setup
MP3 Player	Rec/Play > Recording Mode > Stereo MP3	Two Track Playback, 2-Track Playback
Multi-Track Record	Rec/Play > Recording Mode > Multi-Track USB	Misc. Features, Recording and Recording Setup
Mute Groups	Mute Groups	Misc. Features, Mute Groups



<b>Feature</b>	<b>Navigation</b>	<b>Info System Topic</b>
Network Setup	Menu > Network	Misc. Features, Network Setup
Noise	Menu > Talkback / Noise	Misc. Features, Talkback / Noise
Output Compressor/Limiter	Home > Select a bank > Select an Output > Limiter	Output Channels, Limiter
Output Delay	Home > Select an Aux bank > Select an Aux > Setup	Output Channels, Setup / Delay
Output Delay	Home > Select an Output channel bank > Select a channel > Setup	Output Channels, Setup
Output Filters	Home > Select a bank > Select an Output > Anti-Feedback	Output Channels, Filters
Output GEQ	Home > Select a bank > Select an Output > GEQ	Output Channels, GEQ
Output PEQ	Home > Select a bank > Select an Output > PEQ	Output Channels, PEQ
Output Presets	Home > Select a bank > Select an Output > Presets	Output Channels, Presets
Patch Matrix (TouchMix-30 Pro only)	Menu > Patch Matrix	Misc. Features, Patch Matrix
Phantom Power	Mic. 48V	Misc. Features, Phantom
Pick-off point, dynamics	Menu > Mixer Setup	Misc. Features, Mixer Setup
Pitch Correct	Home > Select a bank > Select a channel > FX	Effects Processor, Pitch Correct
Polarity	Home > Select a bank > Select a Channel > Setup	Input Channels, Setup
Remote Control Setup	Menu > Remote Control	Misc. Features, Remote Control
Reset mixer	Menu > Mixer Setup	Misc. Features, Mixer Setup
Room Tuning Wizard	Wizard > Tuning Wizard	Wizard, Room Tuning
RTA (Channel)	Home > Select a bank > Select a Channel > EQ > RTA On	Misc. Features, RTA
RTA (Selectable)	RTA	Misc. Features, RTA
Sample rate	Menu > Mixer Setup	Misc. Features, Mixer Setup
Scenes	Touch Scenes button (upper left corner of screen)	Misc. Features, Scenes
Security	Menu > Security	Security
Solo In Place (TouchMix-30 Pro only)	Menu > Mixer Setup	Misc. Features, Mixer Setup
Speaker Settings	Home > Select a bank > Select an Output > Setup	Output Channels, Setup
Sub Groups Compressor/ Limiter (TouchMix-30 Pro only)	Home > Select a Sub Group bank > Select a Sub Group > Limiter	Sub Group Channels, Limiter
Sub Groups PEQ (TouchMix-30 Pro only)	Home > Select a Sub Group bank > Select a Sub Group > PEQ	Sub Group Channels, PEQ
Talkback	Menu > Talkback / Noise	Misc. Features, Talkback / Noise
User Buttons	Menu > User Buttons	Misc. Features, User Buttons
Wi-Fi	Menu > Network	Misc. Features, Network Setup

# Nav Strip

Home  Home  
(if needed)



**NOTE:** The examples shown are from the TouchMix-30 Pro. TouchMix-8 and TouchMix-16 will differ slightly.



The Nav Strip provides the primary means of navigating between fader banks. In addition, it provides an overview of all fader positions for the selected mix and any clipping conditions.

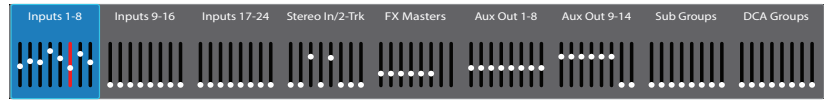

**To access the Nav Strip** – From any screen, press Home once or twice to display Home page.

**Blue Nav Strip Bank** – Indicates the currently selected bank. Touch the bank to select it.

**Nav Strip Titles** – Indicates the type and range of the channels.

**Faders** – The faders represent the current position of all the mixer’s faders for the currently selected mix (Main, Auxes 1 - 14). Fader levels are not adjustable from the Nav Strip

**Red Fader Slot** – This is a “sticky” clipping indication the channel is, or has been clipping. Reduce the input channel trim, then go to Menu > Mixer Setup > Clear Clip, or push the Clear Clip user button.

**Inputs 1–8, 9–16, and 17–24** – Displays the fader settings for mic/line inputs.

**Stereo In/2-Track** – Displays the fader settings for line inputs and for 2-track playback and record.

**FX Masters** – Displays the level of the returns for the internal effects processors.

**Aux Outputs 1–8, 9–14** – Displays the level of the auxiliary outputs.

**Sub Groups 1–8** – Displays the level of the eight Sub Groups (TouchMix-30 Pro only).

**DCA Groups** – Displays the level of the eight DCA master faders. Refer to the [DCA Group Assignments on page 108](#)

## Channel Controls

Input channels are shown on left. FX, Aux, and DCA channels may differ slightly. The Main L/R Channel is visible on most screens.

1. Select button – Displays the user-defined channel name. Touch to access Master Channel controls.
2. **Channel Cue** button – Routes the channel signal to the Phones and Monitor outputs regardless of Mute status. Green indicates “on”.
3. **Pan slider** – Adjust by touch or Master Encoder. Stereo pans are mirrored.
4. **Mic 1** – Represents physical XLR (1) and channel type (In, Aux, FX, etc.).
5. **C** – Indicates the Compressor is engaged. Input channels do not have a Limiter.
6. **G** – Indicates Gate is engaged.
7. **48** – Indicates the Phantom Power is on.
8. **“0”** (Unity) – 0 dB (Meter)
9. **Meter** (Input channel) – Indicates the pre-fader signal level regardless of Mute setting. Can be controlled by source output level, Trim knob or Digital Gain.
10. **Mute** – Silences the channel audio to the Main L/R, Auxiliaries and FX. Does not mute the send to multi-track. Orange color indicates the channel is muted by DCA or Mute Group.
11. Link – Indicates linked adjacent channels. Lower numbered, odd channel links to higher numbered even channel.
12. Playback – Indicates that the input to this channel is a recorded track.
13. Recording Armed – Indicates this channel is armed for recording.
14. **U (unity)** – 0 dB (Fader)
15. Channel/Main Fader – Adjust by touch or Master Encoder. Yellow slot indicates selected.
16. **Assignments** – Indicates to which mixes the channel is assigned: Main (L/R) – all models, Sub Groups (1 – 8) – TouchMix-30 Pro only.
17. **Scene** – Displays the name of the active Scene. Touch to access Scenes.
18. **L** – Indicates the Limiter is engaged
19. **AF** – Indicates the Anti-feedback Filter is engaged
20. **L/R Meters** – Indicate Main output signal level.

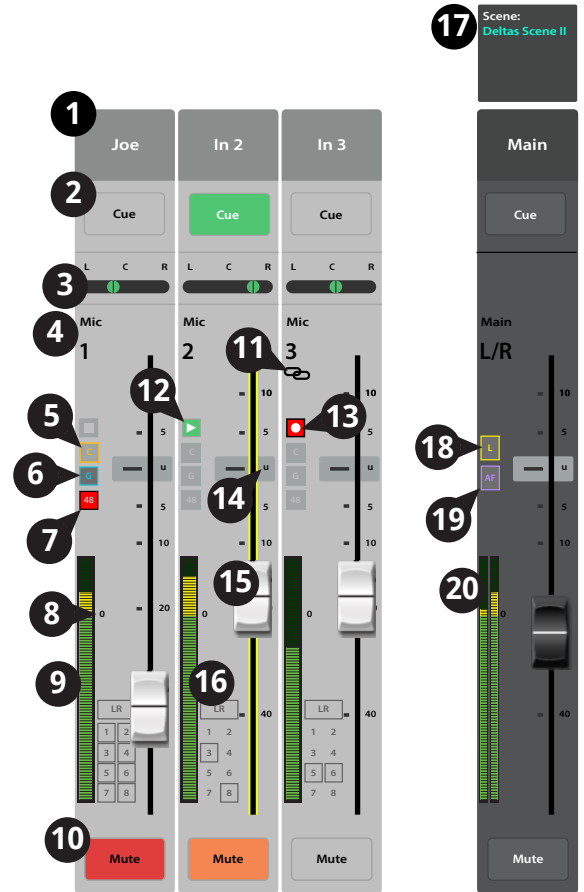

# Input Channels

## Input Channel – Overview

Provides a single-screen view of frequently used controls and indicators for the input channel.



1. **Overview tab** – Selects the Channel Overview screen.

2. **Preset** – Shows the currently selected Preset for this channel. Touch the + to change the Preset.

3. **Polarity Reverse** – Changes the polarity of the signal.

4. **Digital Gain** – Controls and indicates the amount of digital gain (+/- 15 dB) that has been applied to the signal.

5. **Delay** – Controls and indicates the amount of delay (up to 100 msec.) applied to the signal.

6. **Delay In** – Applies / bypasses the delay.

7. **Reset** – Sets all controls for the input channel to the factory default position.

8. **L/R Subs** – (TouchMix-30 Pro only) Indicates the output assignments channel (L/R Main, Sub Groups 1 – 8).

9. **DCA** – Indicates which DCA groups are assigned to the channel.

10. **Mute Groups** – Indicates which Mute groups affect the channel.

11. **Parametric EQ Graph** – A graphic representation of the equalization curve based on the EQ settings. The trace dims to indicate that the EQ is Out (disengaged).

- **EQ Graph Vertical Scale** – Represents audio level from -20 dB to +20 dB.
- **EQ Graph Horizontal Scale** – Represents frequency from 20 Hz to 20 kHz.

12. **EQ In** – Engages / disengages the equalizer for the input channel.

13. **Aux Sends** –

- Displays the system numbers and user-defined names for the Aux channels.
- Adjustable sliders send signal to the associated Aux channel output.
- Mute indicates if the channel's send to an Aux is muted or not.

14. **EQ Handles** – Touch, hold, and drag to change the Frequency and Gain of the associated EQ band. The frequency band button must be engaged to see the EQ Handles. Pinching to change Q is supported on the TouchMix-30 and tablet apps for all models.

15. **Low and High Cut Filter** and **Frequency Bands 1, 2, 3, and 4** – These buttons engage or disengage the associated filter.

To adjust the following parameters, select the field then use the Master encoder or the up/down nudge buttons on a mobile device.

16. **Gain, Bands 1, 2, 3, and 4** – Displays and adjusts gain (+/- 15 dB) of the frequency band.

17. **Low and High Cut Filter Frequency** – Displays and adjusts the knee frequency for the high and low cut filters.

18. **Frequency Bands 1–4 frequency adjustment fields** – Displays and adjusts the center frequency for the four parametric EQ bands.

19. **Comp** –

- **Comp** – Engages or disengages the channel's compressor.
- **Threshold** – Displays and sets the level at which compression begins.
- **Attack** – Displays and sets the time it takes for the compressor to reach its maximum compression when the threshold level is exceeded.
- **Release** – Displays and sets the time it takes for the compressor to cease gain reduction when signal drops below threshold.
- **Ratio** – Displays and sets the amount of compression applied to the signal.



- **Gain** – Displays and sets the overall output gain to makeup any loss after the signal is compressed.

## 20. **Gate** –

To adjust the following parameters, select the field then use the Master encoder or the up/down nudge buttons on a mobile device.

- **Gate** – Engages or disengages the Gate.
- **Threshold** – Displays and sets the signal level at which the Gate allows audio to pass.
- **Attack** – Displays and sets how quickly the gate reacts to a signal that exceeds the threshold.
- **Release** – Displays and sets how quickly the Gate attenuates the audio when signal falls below threshold.
- **Attenuation** – Displays and sets the amount of attenuation applied to the output when the signal is below the Threshold.
- **Hold** – Displays and sets the minimum time the Gate stays open once it is opened, and the length of time the Gate stays open after the input level drops below the Threshold.

## 21. **FX Sends** –

- Displays the system numbers and user-defined names for the FX channels.
- Adjustable sliders send signal from this channel to the associated FX processors.

## 22. **Aux Channel Link icon** – Indicates the two channels are linked.

## 23. **Aux Pan control** – When two channels are linked, the even number send slider becomes a pan control..

## 24. **M** – Indicates if the channel send to the Aux mix is muted.

## Input Channel – Analog Trim

The Trim (gain) control sets the level of the analog input signal just before conversion to digital. The Trim controls are not available on the remote devices. Only Mic/Line Input Channels have Trim controls.



**NOTE:** Proper gain trim adjustment prevents clipping, improves signal-to-noise performance, and allows preset compression and gate dynamics to function as intended.



**NOTE:** The mixer also has digital gain trim. Its settings are stored and recalled with scenes and presets. See “Input Channel Setup” for more detail.

The following controls and indicators are used to set the input gain Trim:

- Trim Controls** – Located above the touchscreen, adjusts sensitivity of mic/line inputs (TouchMix-30 Pro shown).
- Nav Strip** – Touch to select a fader bank.
  - The red line in Inputs 1-8 fader bank is a clip indication that is persistent (sticky). It is cleared using the “Clear Clip” function (User Button 2) or from the Menu screen. Clearing the indication affects only the device (tablet or mixer) on which it was cleared.
- Level Meter (Mic 1)** – Indicating that the signal level in the channel is below unity. If input gain trim is properly adjusted, this will be seen when the source is playing somewhat below its average level
- Level Meter (Mic 2)** – Indicating that the signal level in the channel is slightly above unity. If input gain trim is properly adjusted, this will be seen when the source is playing at its average level.
- Level Meter (Mic 3)** – Indicating that the signal level in the channel is above unity. If input gain trim is properly adjusted, this will be seen when the source is playing somewhat above its average level.
- Level Meter** – Indicating the channel is clipping. Reduce the source output level or mixer input gain and clear the clip indication (User Button 2).
- Input Channel Fader** – Adjusts the output of the channel to the Main L/R outputs, post-fader aux. sends, and Sub-Groups (TouchMix-30 Pro only)

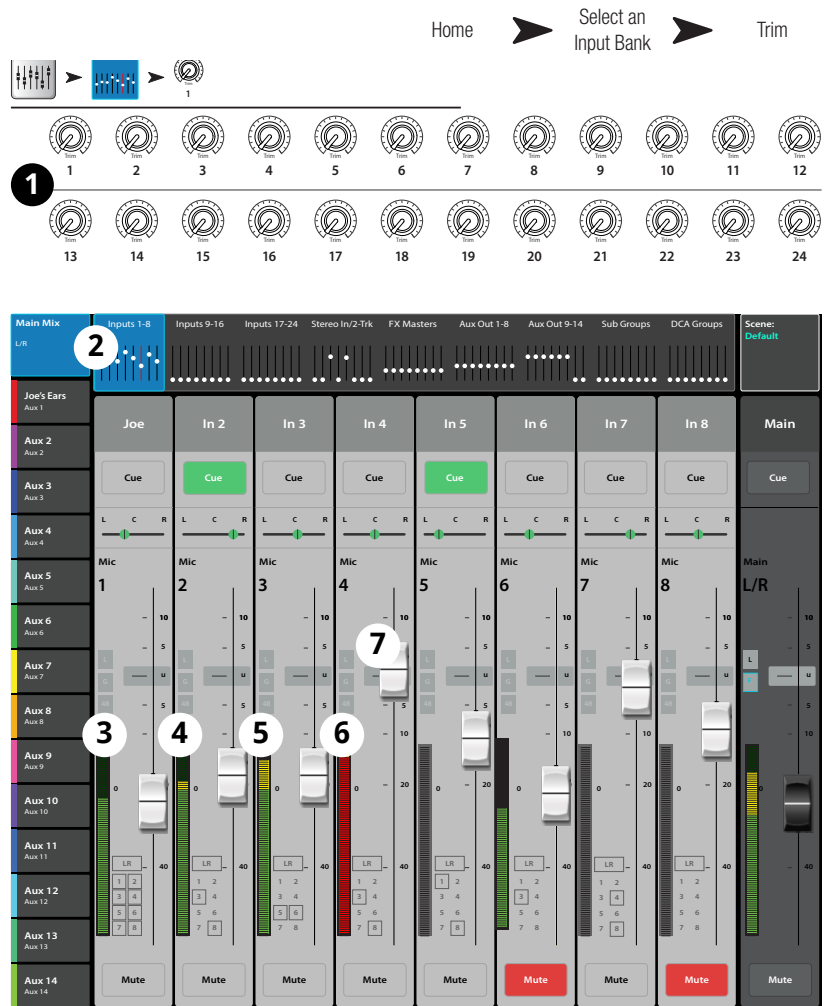

## Input Channel – EQ

Controls and displays the settings for the Input Channel equalization.



1. **EQ tab** – Selects the EQ screen.
2. **EQ In** – Engages / disengages the equalizer.
3. **RTA On** – Engages the Real Time Analyzer display.



**NOTE:** A maximum of two RTA displays for TouchMix-30 Pro, and one RTA display for the TouchMix-8 and -16 are available at a time on any combination of a mixer and tablet devices.



**NOTE:** When the RTA is off, the Parametric EQ graph expands to use the entire graph area.

4. **Simple button** – Hides the Low Cut, High Cut, Frequency, and BW controls. Does not effect existing settings.
5. **Reset button** – Sets all the EQ controls to their factory default position.
6. **RTA display** – Displays the amplitude of the channel signal in 1/3 octave bands. Peak hold is displayed only on tablet devices.
7. **Parametric EQ graph** – A graphic representation of the equalization curve based on the EQ settings. The trace dims to indicate that the EQ is Out (disengaged).
  - **EQ graph vertical scale** – Represents audio level from -20 dB to +20 dB.
  - **EQ Graph horizontal scale** – Represents frequency from 20 Hz to 20 kHz.
8. **EQ Handles** – Touch, hold, and drag to change the Frequency and Gain of the associated EQ band. The frequency band button must be engaged to see the EQ Handles.
9. **Low Cut and High Cut filter buttons** – These filters cut frequencies below or above the frequency set by the corresponding Freq control.
10. **Low Shelf and High Shelf filter buttons** – Changes EQ Band 1 and Band 4 from parametric filters to shelving filters. When a shelf filter is engaged, the Bandwidth control is not available.
11. **Frequency Bands 1, 2, 3, and 4 buttons** – Engages / disengages the associated parametric EQ band. Each band is fully parametric with a frequency range of 20 Hz to 20 kHz.
12. **Gain control knob and readout** – Adjusts the gain at the frequency setting of the associated EQ band. Range of -15 dB to +15 dB.
13. **Freq control knob** (Frequency bands 1 – 4) – Sets the center frequency of the associated EQ band. If the Shelving filter is engaged, the Freq control sets the knee frequency of the shelf filter.
14. **Q knob** – Adjusts the bandwidth of the associated EQ band. When the Shelf Filter is selected, the Bandwidth control is hidden. In addition, Q can be adjusted by “pinching” (TouchMix-30 Pro and tablet apps only).
15. **Freq control knob** (Low and High Cut) – Sets the frequency of the low and/or high cut filter as measured from a point 3 dB below 0 or unity.
16. **◀ ▶ buttons** – Navigates to the next or previous channel. The buttons cycle through the Input, playback, record, and FX channels, then loops back to Input 1.
17. **Channel controls** – Output controls for selected channel. See Channel Controls topic.
18. **Main Channel controls** – Output controls for the Main L/R outputs. See Channel Controls topic.

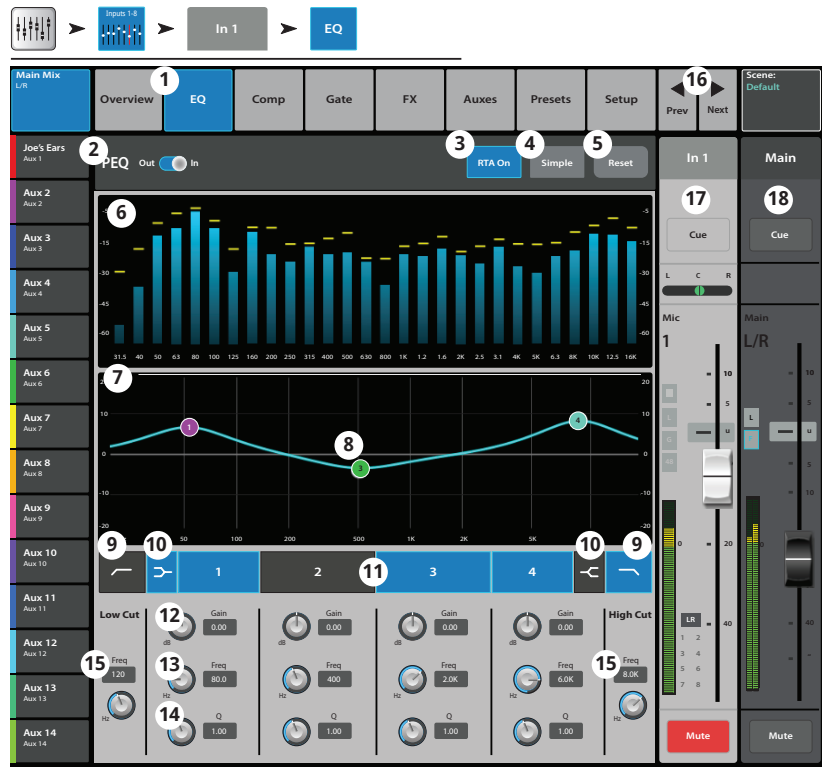

# Input Channel - Compressor

The Compressor controls the dynamic range of a signal above a set Threshold.



1. **Comp tab** – Selects the Compressor screen.

2. **Comp In / Out switch** – Engages and disengages the compressor.

3. **Knee In button**

– Determines how abruptly the compressor transitions in and out of gain reduction as the threshold is crossed.

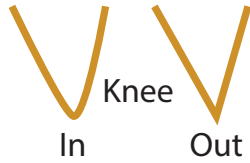

4. **Simple button** – Turns Simple mode on and off. Hides all controls except:

- Comp In
- Simple
- Reset
- Compression

5. **Reset button** – Sets all the Comp controls to their factory default position.

6. **In meter** – RMS input level

7. **G.R. meter** – Gain Reduction – (red) indicates how much the signal is being reduced by the compressor.

8. **Out meter** – Output level after any applied compression

9. **Threshold slider** – Sets the point at which the compressor will begin to reduce signal level.

10. **Compressor graph** – Vertical scale from 0 dB to -60 dB; horizontal measurement is time. When the Compressor is engaged, the trace is displayed.

- **Threshold (A)** – The level at which compression begins.
- **Attack time (B to E)** – The time it takes for the compression to reach its maximum compression after the input exceeds the threshold level.
- **Ratio (A to E)** – The amount of compression applied to the signal.
- **Release time (C to D)** – The time it takes for the compressed signal to rise to the threshold level once the input level no longer exceeds the threshold.

11. **Ratio slider** – Sets the ratio of input level to output level when the signal exceeds the threshold.

12. **Attack slider** – Adjusts how quickly the compressor reacts to a signal that exceeds the threshold.

13. **Release slider** – Adjusts how quickly the compressor stops compressing when signal falls below threshold.

14. **Gain knob** – (Compressor only) Adjusts the overall output gain to makeup any loss after the signal is compressed.

15. **Compressor indicator** – When the Compressor is In, an orange “C” displays on the channel controls strip.

16. **De-Esser knob** – Adjusts the amount of compression at the frequencies of sibilant consonants such as “s”, “z”, and “sh”.

17. **De-Esser button** – Engages or disengages the De-Esser.

18. **Side Chain selector** – (TouchMix-30 Pro only) Selects another input channel to control the compression of the currently selected channel. Touch the Side Chain selector box then use the Master Encoder to adjust.

19. **Side Chain In** – (TouchMix-30 Pro only) Engages or disengages the side chain. When the side chain is disengaged, the input of the currently selected channel controls its own compression.

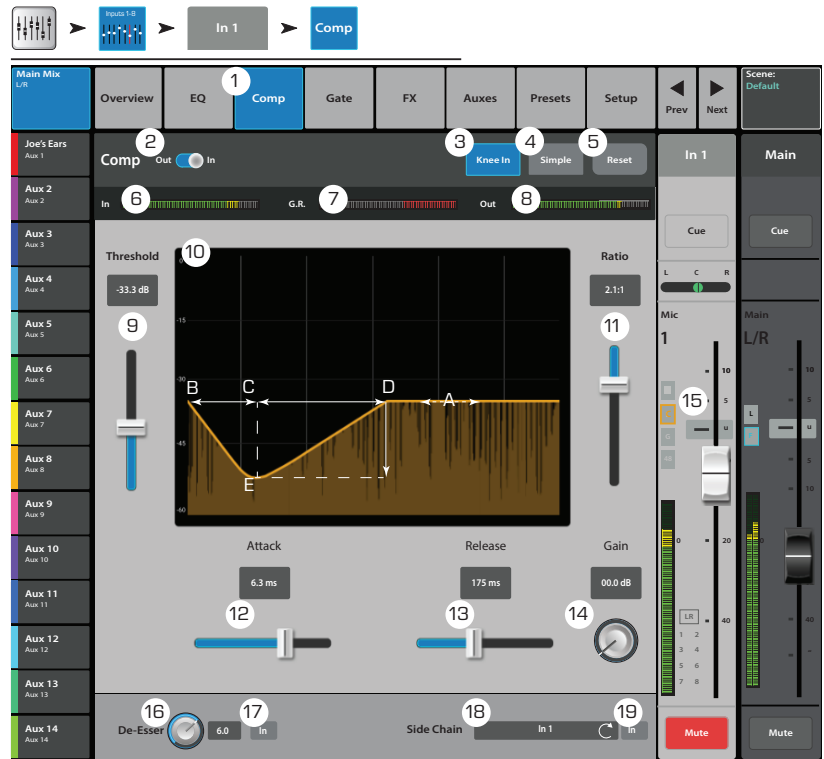



# Input Channel - Gate

The Gate passes audio above a set Threshold, and attenuates audio below the Threshold.



1. **Gate tab** – Selects the Gate Screen.
2. **Gate In switch** – Engages or disengages the Gate.
3. **Simple button** – Turns Simple mode on and off. Hides all controls except:

- Gate In button
- Simple button
- Reset button
- Gating knob

4. **Reset button** – Sets all the Gate controls to their factory default position.
5. **In meter** – RMS input level
6. **G.R. meter** – Gain Reduction – indicates how much the signal is being reduced by the Gate.
7. **Out meter** – Output level
8. **Threshold slider** – Sets the point at which the Gate allows audio to pass.
9. **Gate graph** – When the Gate is engaged, the trace turns green.
  - Threshold (A)
  - Attack time (A-B)
  - Release time (C-D)
  - Attenuation Level (E).

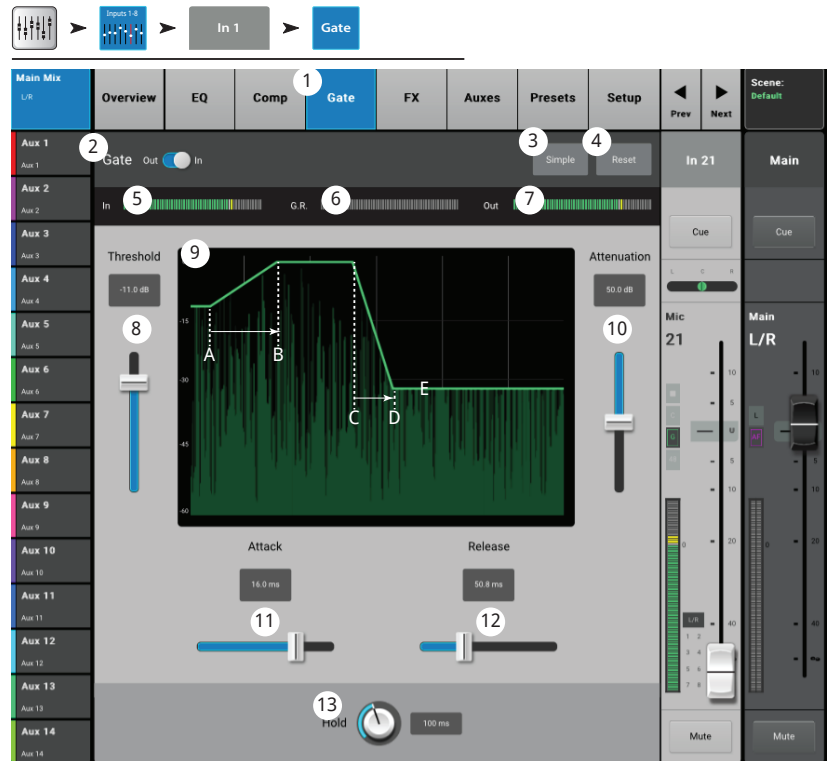

10. **Attenuation slider** – Sets the amount of attenuation applied to the output when the signal is below the Threshold.
11. **Attack slider** – Adjusts how quickly the gate reacts to a signal that exceeds the threshold.
12. **Release slider** – Adjusts how quickly the Gate attenuates the audio when signal falls below threshold.
13. **Hold knob** – Sets the minimum time the Gate stays open once it is opened, and the length of time the Gate stays open after the input level drops below the Threshold.

# Input Channel – FX Sends

Controls how much of the Input channel's audio is sent to the FX devices.



- FX tab** — Selects the FX Sends screen.
- FX Overview button** — Navigates to the FX Overview screen for a view of all 6 FX sends from all inputs.
- Simple button** — Hides the Global FX Parameters for simplified operation.
- Reset button** — Resets the FX sliders, Pre/Post settings, and the Pitch Correct settings. This button does not reset the settings for the FX processors including the Global FX Parameters on this screen.
- FX Buses** – The thumbnail representation of the FX processor takes you to a screen where you can select the processor for that FX send, and adjust the parameters for the selected FX processor.
- FX Label** – The larger text identifies the FX bus number, and does not change. The smaller text can be changed in the FX processor Setup screen.
- FX Send sliders** – Sets the level of audio sent from the channel to the FX mix; “-inf” is off. The digital read-out to the right of the slider indicates the slider setting.
- Global FX Parameters** – Provides control over the two most important parameters of the selected FX device. The parameters will differ depending on the selected processor.
- Pre/Post Fader button** — Selects a pre-fader or post-fader (default) pick-off point for the FX send. Changing this setting will change the pick-off for all inputs.
- Pitch Correct** – Refer to the Pitch Correct topic.

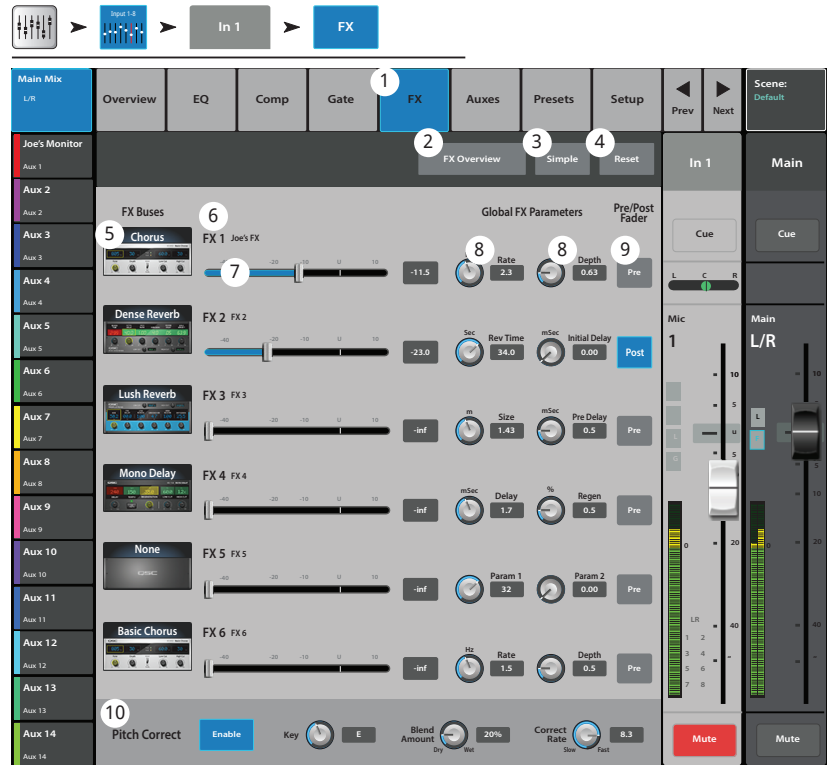

## FX Signal Flow

Input audio passes through the EQ, and Dynamics (compressor and gate). At this point you can split the audio and send it to the FX system (Pre-fader), then the Channel Fader. Or, send the audio through the Channel Fader then split it and send it to the FX system (Post-fader).

“Dry” audio (no FX processing) continues through the Pan control to the Main L/R Fader and Main outputs.

The Pre-fader or Post-fader audio is sent to the Channel FX sends (The diagram shows just one of the FX Sends).

The FX Send slider determines how much of the channel audio is sent (or routed) to the assigned FX processor.

The FX processor works its magic on the audio and transforms the mono input into a stereo signal. The FX Master fader controls how much or how little of the processed (“wet”) signal is combined with the unprocessed (“dry”) audio before going to the Main L/R fader and on to the Main L/R outputs.

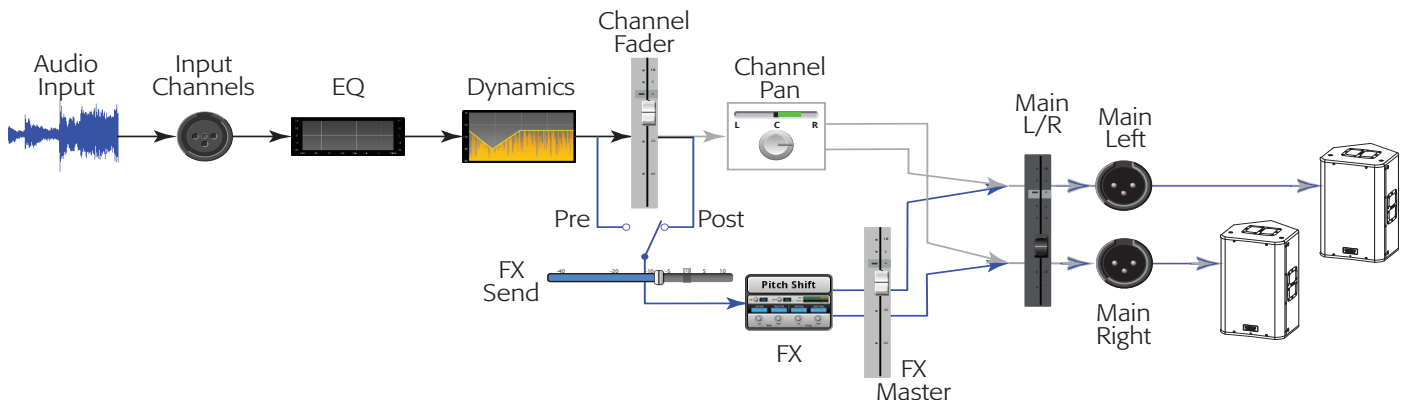

**NOTE:** For detailed information, refer to the Block Diagram.

# Input Channel - Aux Sends

Auxiliary outputs are used to create a mix for stage monitors, in ear monitors, remote speakers or video / broadcast. The auxes may be linked for stereo.



1. **Auxes tab** – Selects the Aux Sends screen
2. **Aux Overview button** – Navigates to the Aux Overview which displays all Aux mixes on a single screen.
3. **Reset button** – Resets all Aux Sends controls, for the selected input channel, to the factory default.
4. **Aux mix system number** – Displays the number of the associated Aux Output.
5. **Aux mix friendly name / button** – Displays the user-defined Aux mix name. Touch to navigate to the associated Aux output controls.
6. **Aux send sliders** – Sets the level of audio sent from the channel to the Aux mix; -40 dB (-Inf) is off.
7. **Level** – Provides a numeric display of the Aux send level.
8. **Mute** – Mutes the send from the channel to the associated Aux mix. Does not effect any other mixes or sends.
9. **Pick-off point button** – Indicates if the Aux Buss is taking a **Pre Fdr/ Post Fdr / Pre Dyn / Pre All signal**. Touch to navigate to the associated Aux output controls to change the setting. Affects all sends for the associated aux mix.
10. **Aux link indicator** – Indicates the Aux channels are linked. You can link Aux channels from the Input channel Aux Sends screen by touching one of the Aux mix buttons, or one of the pick-off buttons. Both take you to the Aux channel Setup screen where linking is accomplished.
11. **Aux Sends pan slider** – Pans the signal between a linked pair of auxes.

## Auxiliary Channels Flow Diagram

The Pre All, Pre Dyn, Pre Fader, and Post Fader buttons are radio-buttons that provide options for where the Aux Outputs get their signal. In the figure below, the Pre Fader button is selected.

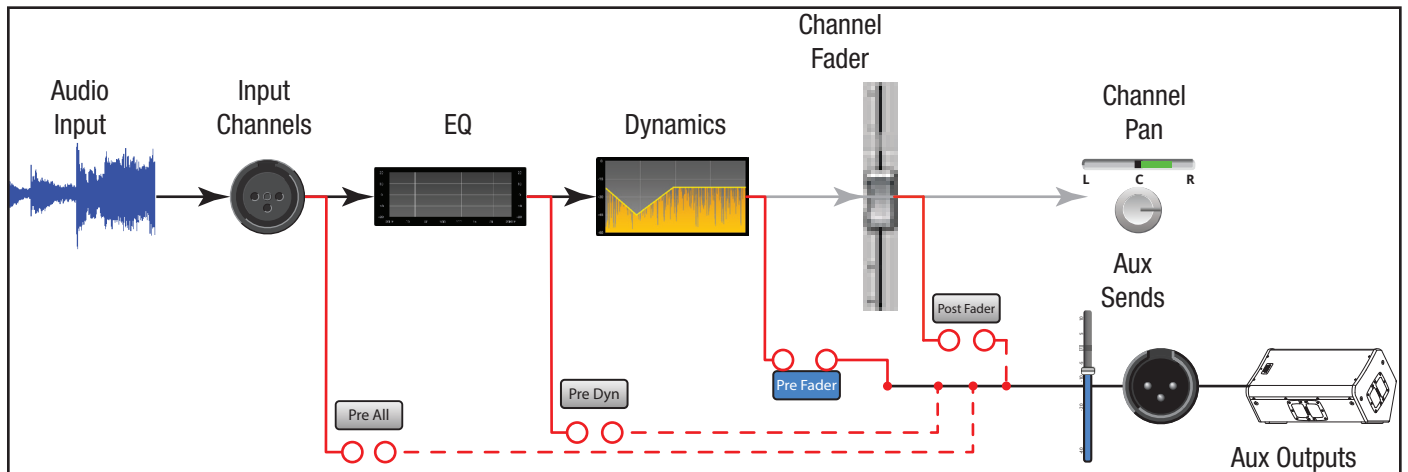

**NOTE:** For detailed information, refer to the Block Diagram.

# Input Channel – Presets

Recall presets from the factory library. Store and recall user presets.



- Presets tab** – Selects Presets screen.
- Current Preset** – Displays the name of the current preset.
- Preset Info** (Factory only) – Touch to display details about a preset. Information provided may include style of music, instrument details, microphone/pick-up type and position, or other helpful information.
- Factory / User switch** – Toggles between Factory and User preset libraries.
  - Factory Presets – A library of QSC designed input-channel presets.
  - User Presets – User Presets may be stored to and recalled from Internal memory or an External (USB) storage device.
- Instrument list** (Factory only) – Displays a list of instrument categories.
- Type list** (Factory only) – Displays a list of specific instruments within the selected Instrument category.
- Preset Name list** (Factory only) – Displays a list of professionally voiced, live-sound presets.
- Recall button** – Recalls the selected Preset. Recalls all parameters for an Input Channel except: Analog/Multi-track state, Track/Arm button, Cue, Mute, Channel Link state
- Omit Levels & Assignments switch** – When engaged, channel, FX and aux levels as well as mute, sub group and DCA assignments are not effected by preset recall.
- Omit Name switch** – When engaged, Channel Name is not effected when a preset is recalled.
- Omit Phantom switch** – When engaged, Phantom power setting is not effected when a preset is recalled

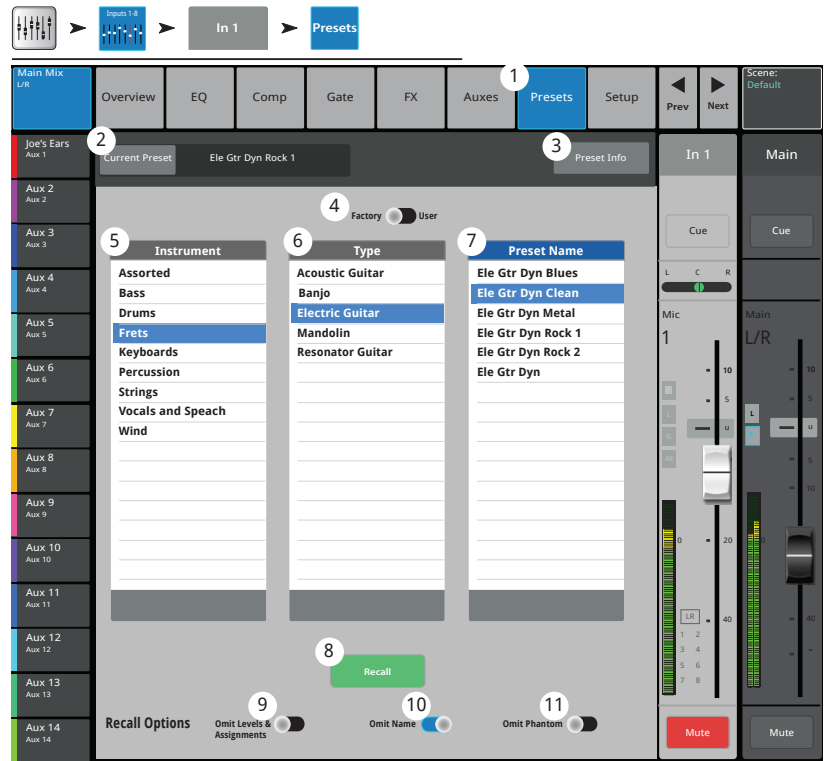

**NOTE:** The following controls are available only when the Factory / User switch is set to User.

- Save / Save As Button** – Displays the **Save Preset As** screen with options for naming a preset and selecting internal or USB storage destination.
- Mixer list** – Displays a list of user-defined presets that are saved on the mixer.
- External (USB) list** – Displays a list of user-defined presets that are saved on a USB drive currently connected to the mixer.
- Copy to USB button** – Copy the selected Internal preset to a USB drive connected to the mixer.
- Copy to Mixer button** – Copy the selected USB preset to the Internal Mixer storage.
- Delete button** – Select a preset and touch this button to delete the preset.

**NOTE:** When saving a preset using an external tablet device do not use unsupported characters in the name. Supported characters are 0 to 9, A to Z, a to z, a period (.), hyphen (-), equal sign (=), exclamation point (!), parenthesis, underscore (\_), or plus sign (+).

- Save button** – Saves the preset to the location indicated by the Internal / External (USB) switch. In addition, the Save button recalls the preset.
- Cancel button** – Cancels the Save operation
- File name field – This field displays the currently recalled preset name. There are two options:
  - Choose to keep the same name. If the name exists in the target location, confirmation is required to overwrite.
  - Change the name partially or in whole. If the name does not exist in the selected location, the preset saves.
- Storage Location switch** – Select either Mixer or USB for the location in which the preset is to be saved.

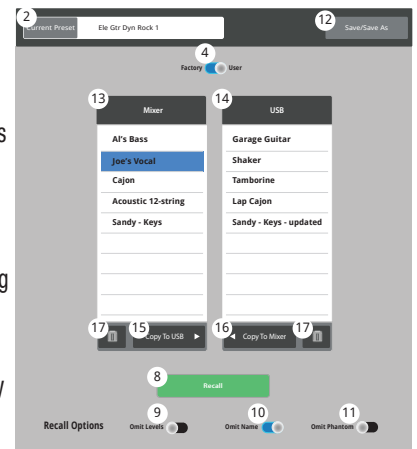

## USER PRESET SCREEN

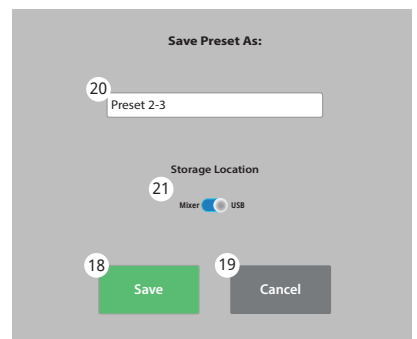

## Save Preset As Screen

# Input Channel - Setup

Channel Setup is provided for all input channels. Line input channels do not have Phantom power controls.



1. **Setup** – Selects the Setup screen
2. **Name** – Displays the name of the channel. Touch to display a keyboard and rename the channel.
3. **Link** – Links adjacent channels. The odd numbered channel settings are copied to the even numbered channel. Pan settings are mirrored. Only odd > even pairings are supported – even > odd pairings are not.
4. **Reset** – Resets the controls for this channel to factory defaults.
5. **Playback and Recording**

When one of these buttons is engaged, the other is not displayed. The example above is for illustration only.

- **Digital Input** – (TouchMix-30 Pro only) Selects the channel's analog or digital input as the signal source. The digital source may be from a USB recording session or from a DAW (see Rec/Playback for more information). Green = digital, gray = analog.
- **Recording (Arm)** – When engaged, the audio on this channel will be recorded on the USB Drive. Available only when the External Recording & Playback Mode is set to Multitrack USB Drive.

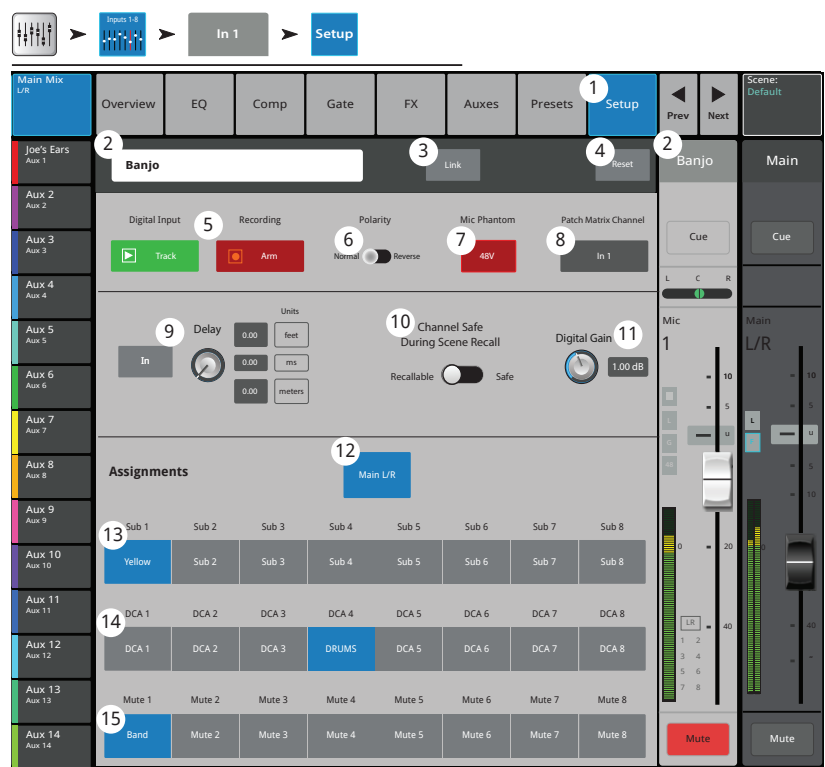

6. **Polarity** – Touch to change polarity of the channel output.
7. **Mic Phantom** – Turns 48V phantom power on/off for the channel (microphone inputs only).
8. **Patch Matrix Channel** – (TouchMix-30 Pro only) Displays the current setting for this channel in the Patch Matrix. If another channel has been patched to this channel, the field would display the patched channel's number.
9. **Delay** – Delays the input signal from 0.00 to 100 milliseconds. Touch the In button to activate the delay.
10. **Channel Safe During Scene Recall** – Setting this switch to Safe, protects the channel controls from being changed when a Scene is recalled.
11. **Digital Gain** – Applies +/- 15 dB of digital gain to the channel signal independently of the channel's analog gain trim. The setting of this control is stored and recalled with a scene or preset. When Track is selected as the source, the control applies to the digital input.
12. **Main L/R** – Assigns the channel's output to the Main Left / Right mix. The factory default is on – assigned to Main L/R.
13. **Sub Groups** – (1 through 8 – TouchMix-30 Pro only) – Assigns the output of the channel to one or more of the eight Sub Groups. User-assigned names display on the buttons. See the Sub Groups topic.
14. **DCA Group** (1 through 8) – Assigns the channel to DCA Groups. User-assigned DCA Group names display on the buttons. See the DCA Groups topic.
15. **Mute Groups** (1 through 8) – Assigns the channel to Mute Groups. User-assigned Mute Group names display on the buttons. See the Mute Groups topic.

# Output Channels

## Output Channel – Overview

Provides a single-screen view of frequently used controls and indicators for the output channel.



1. **Overview tab** – Selects the Channel Overview screen.
2. **Preset** – Shows the currently selected Preset for this channel.
3. **Pick-off point** – (Auxes only) Determines where the signal for the output channel is taken.
4. **Delay** – Controls and indicates the amount of delay (up to 100 msec.) applied to the signal.
5. **Delay In** – Applies / bypasses the delay.
6. **Reset** – Sets all controls for the input channel to the factory default position.
7. Description of the Current Preset
8. **DCA** – Indicates which DCA groups are assigned to the channel.
9. **Mute** – Indicates which Mute groups control the channel.

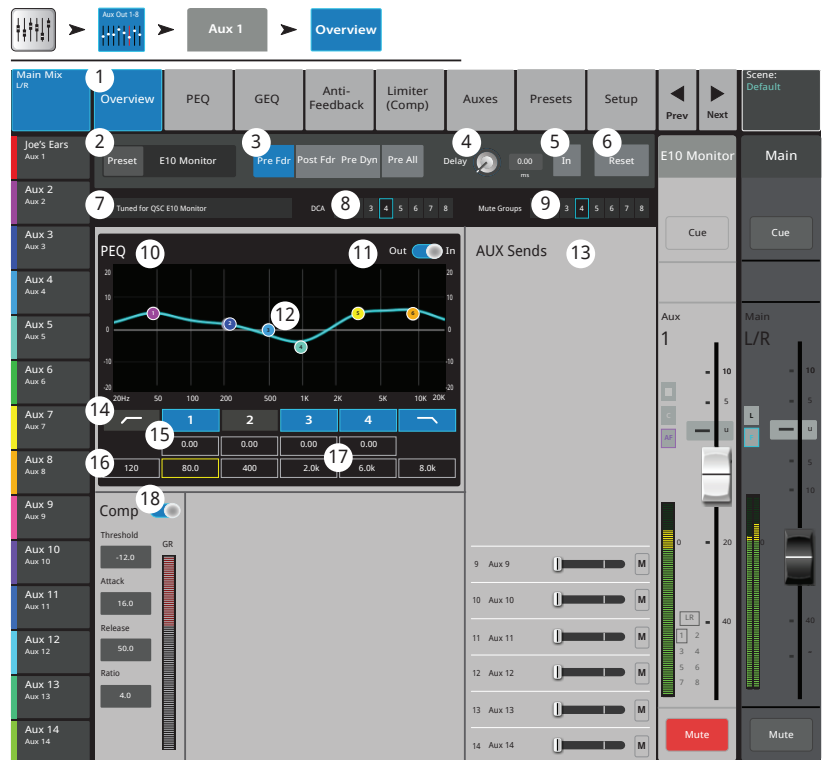

10. **Parametric EQ Graph** – A graphic representation of the equalization curve based on the EQ settings. When the EQ is engaged, the trace becomes brighter.
  - **EQ Graph Vertical Scale** – Represents audio level from -20 dB to +20 dB.
  - **EQ Graph Horizontal Scale** – Represents frequency from 20 Hz to 20 kHz.
11. **EQ Out/In** – Engages / disengages the equalizer for the channel.
12. **EQ Handles** – Touch, hold, and drag to change the Frequency and Gain of the associated EQ band. The frequency band button must be engaged to see the EQ Handles.
13. **Aux Sends** – (TouchMix-30 Pro only)
  - Aux sends 9 – 14 are available for Aux Outputs 1 – 8 only,
  - Displays the system numbers and user-defined names for the Aux channels.
  - Adjustable sliders send signal to the associated Aux channel output.
  - Mute indicates if the channel's send to an Aux is muted or not.
14. **Low and High Cut Filter** and **Frequency Bands 1, 2, 3, and 4** – These buttons engage or disengage the associated filter.

To adjust the following parameters, select the field then use the Master encoder or the up/down nudge buttons on a mobile device.

15. **Gain, Bands 1, 2, 3, and 4** – Displays and adjusts gain (-15 to +15 dB) for the selected frequency band.
16. **Low and High Cut Filter Frequency** – Displays and adjusts the knee frequency for the high and low cut filters.
17. **Frequency Bands 1–4 frequency adjustment fields** – Displays and adjusts the center frequency for the four parametric EQ bands.



**NOTE:** The following section can be a Compressor or Limiter depending on the Comp/Limit switch on the Comp/Limiter tab.

18. **Comp** –
  - **Comp** – Engages or disengages the channel's compressor.
  - **Threshold** – Displays and sets the level at which compression begins.
  - **Attack** – Displays and sets the rate at which the compressor reaches its maximum compression when the threshold level is exceeded.
  - **Release** – Displays and sets the rate at which the compressor ceases gain reduction when signal drops below threshold.
  - **Ratio** – Displays and sets the amount of compression applied to the signal.



## Output Channel – GEQ

Controls and displays the settings for Main or Auxiliary output graphic equalization.

Home ➤ Touch an Aux Bank ➤ Touch an Aux Channel ➤ Touch GEQ Tab

1. **GEQ tab** – Selects the GEQ screen.
2. **GEQ In/Out switch** – Engages / disengages the equalizer.
3. **Tuning In/Out switch** – Engages / disengages the settings established by the Room Tuning Wizard. See the Room Tuning Wizard topic for more information.
4. **Tuning Wizard button** – Starts the tuning wizard for the selected channel.
5. **RTA On** – Turns the RTA (Real-time Analyzer) on and off.
6. **Reset** – Sets all EQ controls to factory default values.
7. **RTA graph** – Displays the amplitude of the channel signal in 1/3 octave bands. Peak hold is displayed only on tablet devices.
8. **Graphic Equalizer** – Displays the controls for the 1/3 octave graphic equalizer. If the Tuning switch is on, a second set of EQ fader caps (blue outline) will be displayed to indicate the settings established by the Room Tuning Wizard.
9. **Prev / Next** – Navigates to the next or previous channel. The buttons cycle through the Input, Playback, Record, and FX channels, then loops back to Input 1.
10. **Channel controls** – Controls for selected Output channel. See Channel Controls topic.
11. **Main Channel controls** – Controls for the Main L/R outputs. See Channel Controls topic.

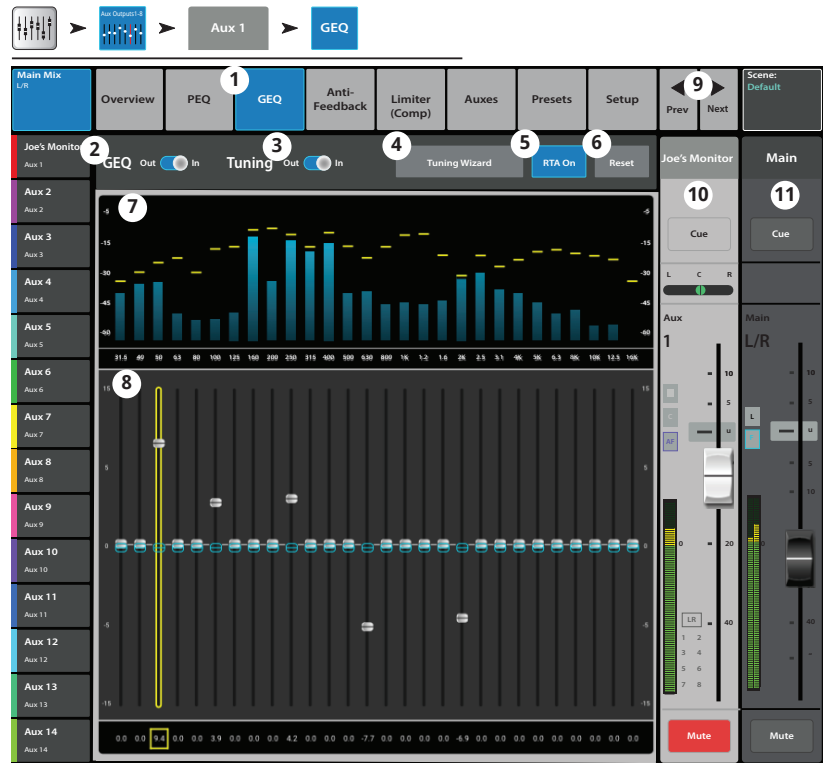

## Output Channel – PEQ

Controls and displays the settings for the Main or Auxiliary output parametric equalization.

Home ➔ Touch an Aux Bank ➔ Touch an Aux Channel ➔ Touch the PEQ Tab

1. **PEQ tab** – Selects the PEQ screen.
2. **PEQ In/Out switch** – Engages / disengages the equalizer.
3. **RTA On button** – Turns the RTA (Real-time Analyzer) on and off.



**NOTE:** When the RTA is off, the Parametric EQ graph expands to use the entire graph area.

4. **Simple button** – Hides the Low Cut, High Cut, Frequency, and BW controls. Does not effect existing settings.
5. **Reset button** – Sets all EQ controls to factory default values.
6. **RTA graph** – Displays the amplitude of the channel signal in 1/3 octave bands. Peak hold is displayed only on tablet devices.
7. **Parametric EQ graph** – A graphic representation of the equalization curve based on the EQ settings. The trace dims to indicate that the EQ is Out (disengaged).

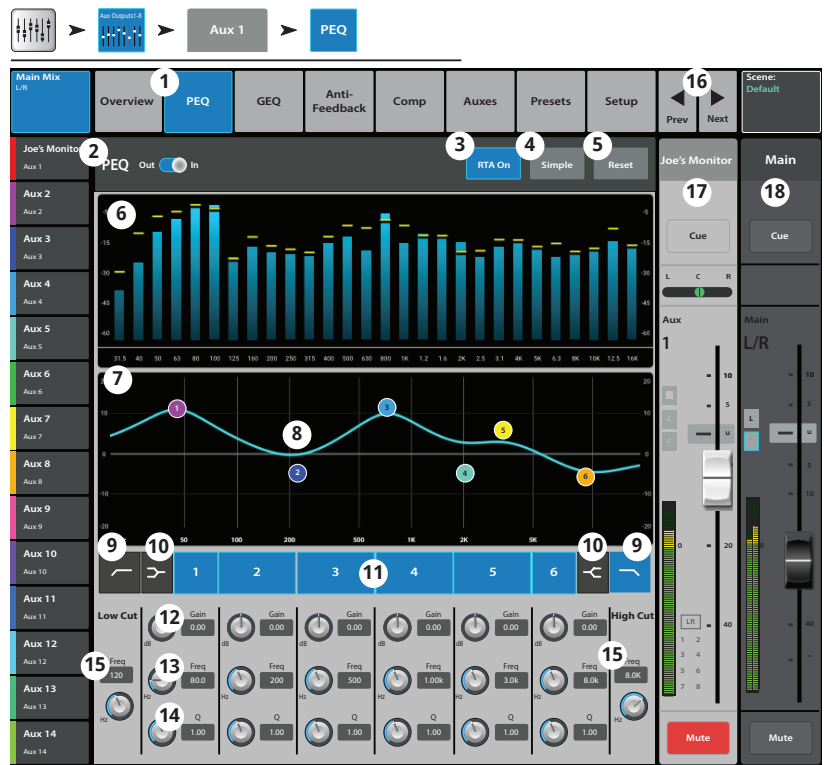

- **EQ Graph vertical scale** – Represents audio level from -20 dB to +20 dB.
  - **EQ Graph horizontal scale** – Represents frequency from 20 Hz to 20 kHz.
8. **EQ Handles** – Touch, hold, and drag to change the Frequency and Gain of the associated EQ band. The frequency band button must be engaged to see the EQ Handles.
  9. **Low and High Cut Filter buttons** – These filters cut frequencies below or above the frequency set by the corresponding Freq control.
  10. **Low and High Shelf Filter buttons** – Changes EQ Band 1 and Band 6 from parametric filters to shelving filters. When a shelf filter is engaged, the Bandwidth control is not available.
  11. **Frequency Bands 1 - 6 In/Out buttons** – Engages / disengages the associated parametric EQ band.
  12. **Gain knob** – Adjusts and displays the gain at the frequency setting of the associated EQ band. Range of -15 dB to +15 dB.
  13. **Freq knob** – Adjusts and displays the center frequency of the associated EQ band. The range is 20 Hz to 20 kHz for all bands. If the Shelving filter is engaged, the Freq control sets the knee frequency of the shelf filter.
  14. **Q knob** – Adjusts the bandwidth of the associated EQ band. When the Shelf Filter is selected, the Bandwidth control is hidden. Q may also be adjusted by “pinching” (TouchMix-30 Pro and tablet apps only).
  15. **Freq knob (Low and High Cut)** – Sets the knee frequency of the low and/or high cut filter as measured from a point 3 dB below 0 or unity.
  16. **Prev / Next buttons** – Navigates to the next or previous channel. The buttons cycle through the Input, Playback, Record, and FX channels, then loops back to Input 1.
  17. **Channel controls** – Output controls for selected channel. See Channel Controls topic.
  18. **Main Channel controls** – Output controls for the Main L/R outputs. See Channel Controls topic.



# Output Channel – Compressor / Limiter

When set as a Limiter, prevents the audio level from exceeding a preset threshold.



1. **Comp / Limiter tab** – Selects the Comp / Limiter screen. Note that the label on this tab will change depending on the setting of the Comp/Limiter switch.
2. **Comp / Limiter In/Out switch** – Engages or disengages the compressor or limiter. Note that the label on this tab will change depending on the setting of the Comp/Limiter switch.
3. **Comp/Limit switch** – Selects Compressor or Limiter mode. If “Comp” is selected, the processor is identical in operation to the input channel compressors.
4. **Knee In button** – The knee determines whether the compressor/limiter transitions abruptly or gradually as the threshold is crossed.
5. **Simple button** – Hides all controls except:
  - Limiter In button
  - Simple button
  - Reset button
6. **Reset button** – Sets all the Limiter controls to their factory default position.
7. **In meter** – RMS input signal level
8. **GR meter** – Gain Reduction – indicates how much the signal level has been reduced by the Limiter.
9. **Out meter** – Output signal level
10. **Threshold slider** – Sets the point at which the compressor/limiter will begin to reduce signal level.
11. **Limiter graph** – When the Limiter is engaged, the trace is blue.
  - **Threshold (A)** – The level at which limiting begins.
  - **Attack time (B to C)** – The time it takes for the limiter to reach maximum limiting after the input exceeds the threshold level.
  - **Ratio (A to E)** – The amount of limiting applied to the signal.
  - **Release time (C to D)** – The time it takes for the limited signal to rise to the threshold level once the input level no longer exceeds the threshold.
  - Vertical scale = dB
12. **Ratio slider** – Sets the ratio of input level change to output level change when the signal exceeds the threshold.
13. **Attack slider** – Adjusts how quickly the processor reacts to a signal that exceeds the threshold.
14. **Release slider** – Adjusts how quickly the processor stops compressing or limiting when signal falls below the Threshold.



# Output Channel - Anti-Feedback

Available on the Main L/R and Aux outputs, these narrow, cut-only filters are used for dealing with feedback.



1. **Anti-Feedback tab** – Selects the Anti-Feedback screen
2. **Filters In/Out** – Engages or bypasses the filters.
3. **Feedback Frequency** – The Anti-Feedback system automatically identifies and displays suspected feedback frequencies.
4. **Manual Kill** – When a suspected feedback frequency is identified, touching this button applies a filter at that frequency.
5. **Feedback Wizard** – The Feedback Wizard assists in finding and cutting feedback-prone frequencies. Touching this button opens the Feedback Wizard which will guide the operator through the process.
6. **Reset** – Sets all the Filter controls and markers to their factory default position. Note that the Feedback Wizard will only use a filter if its Cut has been set to 0.0.
7. **Display** – Shows the frequency and depth (cut) of applied filters.

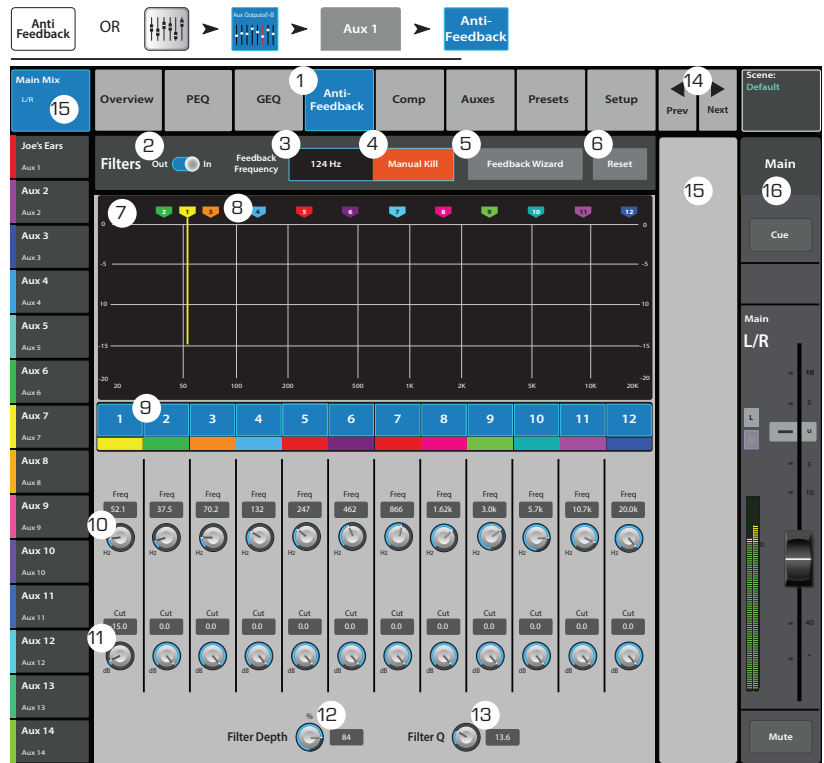

- **Vertical scale** = dB

- **Horizontal scale** = frequency

8. **Filter markers** – These markers are color-coded to correspond with their associated controls. Horizontal position indicates frequency. The amount of cut is indicated by a descending vertical line. Twelve filters - TouchMix-30 Pro, eight filters - TouchMix-8 and -16.



**NOTE:** Markers and their associated frequency controls are not tied to a specific frequency band. Marker 1 may attenuate a high frequency, while Marker 12 may attenuate a low frequency.

9. **Filter In/Out** – The numbered buttons engage/disengage the filters.
10. **Freq** – Sets the center frequency of a filter.
11. **Cut** – Adjusts amount of Cut (or attenuation) for a filter. Range is from 0.00 dB to -20.0 dB.
12. **Filter Depth %** – Increases or reduces the depth (amount of cut) for all the filters.
13. **Filter Q** – Adjusts the width of the filter from a Q of 6 (0.05 octave) to a Q of 30 (0.24 octave).
14. **◀/▶ Buttons** – Navigates to the next or previous channel. The buttons cycle through the Input, Playback, Record, and FX channels, then loops back to Input 1. If you start in the Auxes, the buttons cycle through the Auxiliary outputs and the Main L/R channels.
15. **Channel Controls** – Output controls for selected channel. See Channel Controls topic. There are no controls displayed because there is no Aux Master channel selected, only the Main L/R mix is selected.
16. **Main Channel Controls** – Output controls for the Main L/R outputs. See Channel Controls topic.

## Output Channel - Auxes (TouchMix -30 Pro only)

Auxiliary outputs 1 through 8 may be mixed to Aux Mixes (buses) 9 through 14. In addition, the Main L/R and Sub Groups can send audio to all 14 Auxes.

- Auxes tab** – Selects the Aux Sends screen
- Aux Overview** – Navigates to the Aux Overview which displays all Aux mixes for the selected Fader Bank.
- Reset** – Resets all Aux Sends controls for the selected input channel, to the factory default.
- Aux send number** – Displays the number of the associated Aux Output.
- Aux master name** – Displays the Aux mix name. Touch to navigate to the associated Aux output controls.
- Aux send sliders** – Sets the level of audio sent from the channel to the Aux output; -40 dB (-Inf) is off.
- Gain** – Provides a numeric display of the Aux send level.
- Mute** – Mutes the send from the channel to the associated Aux mix. Does not effect any other mixes.
- Pick-off point** – Indicates if the Aux Buss is taking a **Pre All / Pre Dyn/ Pre Fdr / Post All signal**. Touch to navigate to the associated Aux output controls to change the setting.

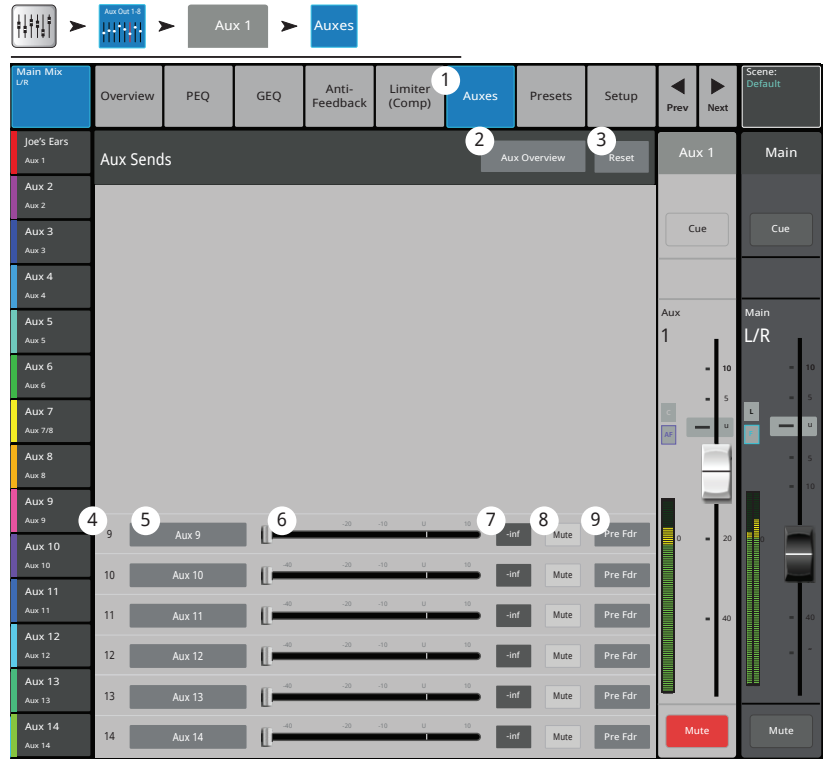

## Output Channel – Presets

Save, recall and copy the settings associated with an Aux, Sub Group or Main L/R output channel.



1. **Presets tab** – Selects the Presets screen.
2. **Current Preset** – Displays the name of the current active preset for the selected channel.
3. **Save/Save As** – Displays a page with options for naming a preset and selecting internal or USB storage destination.
4. **Factory presets list** – Displays a list of factory programmed presets. Voicings for QSC passive loudspeakers are provided. Reset sets all output channel's parameters to their factory default state. The Reset preset is at the bottom of the list, scroll down to see.
5. **Mixer presets list** – Up to 100 Internal Presets may be stored (saved) to and recalled from the mixer's internal memory.
6. **USB presets list** – Up to 100 External Presets may be stored (saved) to and recalled from an External (USB) storage device.
7. **Selected preset** – When a preset is selected, the preset's background is highlighted blue, and the list's title is highlighted blue.
8. **Delete button** – Select a User Preset and touch this button to delete the Preset.
9. **Copy to USB button** – Copy the selected Preset to a connected USB drive.
10. **Copy to Mixer button** – Copy the selected Preset to the Internal Mixer storage.
11. **Recall button** – Recalls stored output channel settings including EQ, limiter, filter, mute assignments, DCA assignments, link state. Levels and tuning settings may be recalled or omitted (see 12 and 13 below).
12. **Omit Levels & Assignments switch** – When set to On, recalling the preset will not change any levels or assignments to Mute, DCA or Sub groups.
13. **Omit Tuning switch** – When set to On, recalling the preset will not change the anti-feedback tuning settings.
14. **Omit Phantom** – When set to On, recalling the preset will not change the Phantom Power settings.
15. **Channel controls** – Output controls for selected channel. See Channel Controls topic.
16. **Main Channel controls** – Output controls for the Main L/R outputs. See Channel Controls topic.



# Output Channel – Setup / Delay

Various utility setup functions for Aux and Main output channels.

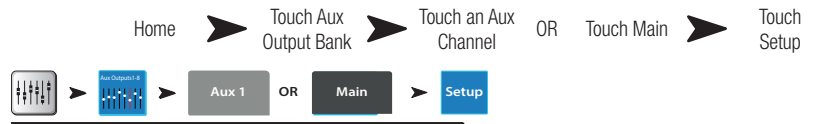

1. **Setup Tab** – Selects the Setup screen
2. **Channel Name** – Displays the channel name. Touch to display a keyboard and rename the output.
3. **Link** (Auxes only) – Links adjacent channels. Odd numbered channel settings are copied to the even numbered channel. Pan settings are mirrored. Only odd > even linking is supported.
4. **Reset** – Returns Setup parameters to factory default values.
5. **Aux Pick-Off** (Auxes only)– Determines where the aux signal is taken from the input channel signal flow. The selections are: Pre Fdr (default)/ Post Fdr / Pre Dyn / Pre All.
6. **QSC Amplifier and Speaker Settings** – Displays tools to assist in optimizing gain structure and other parameters for selected QSC amplifiers and loudspeakers.
7. **Delay In** – Engages or disengages the Delay.
8. **Delay** – Displays and controls the output delay. Readouts are provided in milliseconds, feet, and meters.
9. **Channel Safe During Scene Recall** – Setting this switch to Safe prevents channel settings from being changed when a Scene is recalled.
10. **Connector Mode** – (TouchMix-16 only) Converts auxes 7/8 and 9/10 from stereo outputs with unbalanced TRS jack to mono, balanced outputs. Default is Stereo Mode.
11. **DCA Group Assignments** – Select the DCA Groups this channel is to be part of. User-assigned names display on the buttons. See the DCA Groups topic.
12. **Mute Group Assignments** – Select the Mute Groups this channel is to be part of. User-assigned names display on the buttons. See the Mute Groups topic.

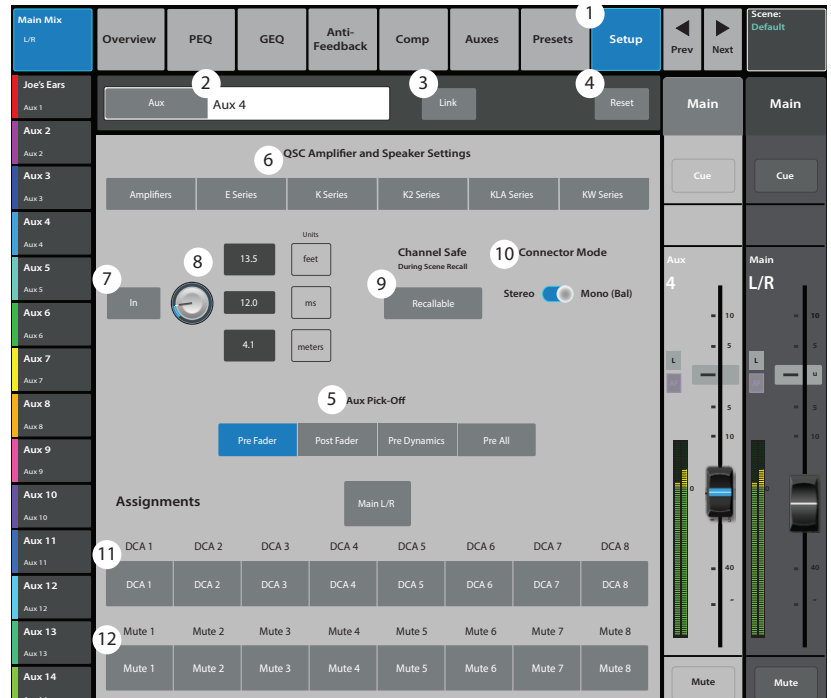

## Output – Speaker Settings

Provides Gain setting recommendations for QSC powered loudspeakers. Also provides a list of available loudspeaker presets for various applications on both powered and passive loudspeakers. Note that these presets are not available for all QSC loudspeakers.

1. **Select Speaker** – Touch to select the QSC loudspeaker connected to the output.
2. **Preset** – Select a preset for the connected loudspeaker.
  - a. If you are using a powered loudspeaker make sure the DSP is set to the default preset.
  - b. If you are using an E Series (passive) loudspeaker make sure that any DSP in the amplifier is set to the default preset. The QSC GXD amplifier has a setting for TouchMix mixers. Refer to the GXD topic.
3. **Set the Gain** – Adjust the Gain knob on your powered loudspeaker to the position indicated by the illustration and the text below it.
4. When finished, touch the Done button.

Press Home ➔ Touch an Output Bank ➔ Touch an Output Channel ➔ Touch K Series

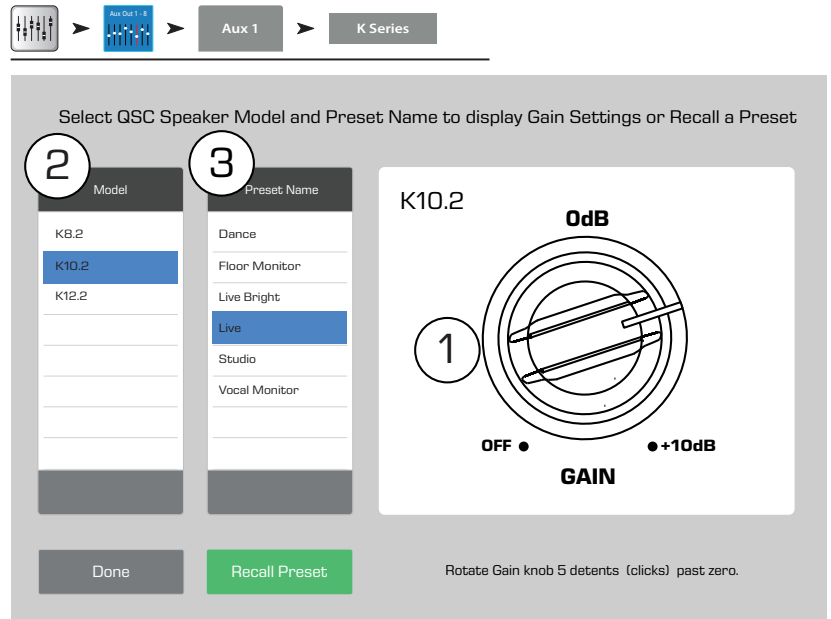

**NOTE:** Subwoofer level may be adjusted to get the desired relative high/low balance.

When the speakers are adjusted as directed, signal to noise ratio is optimized and the output meters on the mixer reflect how much speaker system headroom is available. Note that the LIMIT LED on the speakers is not a Clip indicator. It will be lit before the mixer's meters indicate any overdrive. This is because the speakers' DSP is preventing dynamic peaks in the program from overdriving the amplifier and speakers.

## GXD Amp Settings

Provides help in properly adjusting QSC GXD Amplifier when used with the TouchMix.

Press Home ➔ Touch an Output Bank ➔ Touch an Output Channel ➔ Touch Amplifiers

### On the GXD Amplifier

1. **Home** – If the amplifier's Gain screen is not displayed, press the Home button. If the Gain screen is displayed, skip to the next step.
2. Adjust the Gain A and Gain B knobs for 0.0 dB. **Enter** – Moves to the next screen.
3. Adjust the Gain B/DSP Control knob to select Stereo DSP. **Enter** – Moves to the next screen.
4. Adjust the Gain B/DSP Control knob to select Sensitivity. **Enter** – Moves to the next screen.
5. Adjust the Gain B/DSP Control knob to select TouchMix. **Enter** – Confirms selection.
6. **Home** – Returns to the Home screen.

### On the TouchMix

1. **Done** – Closes the GXD Amp Settings pop-up.

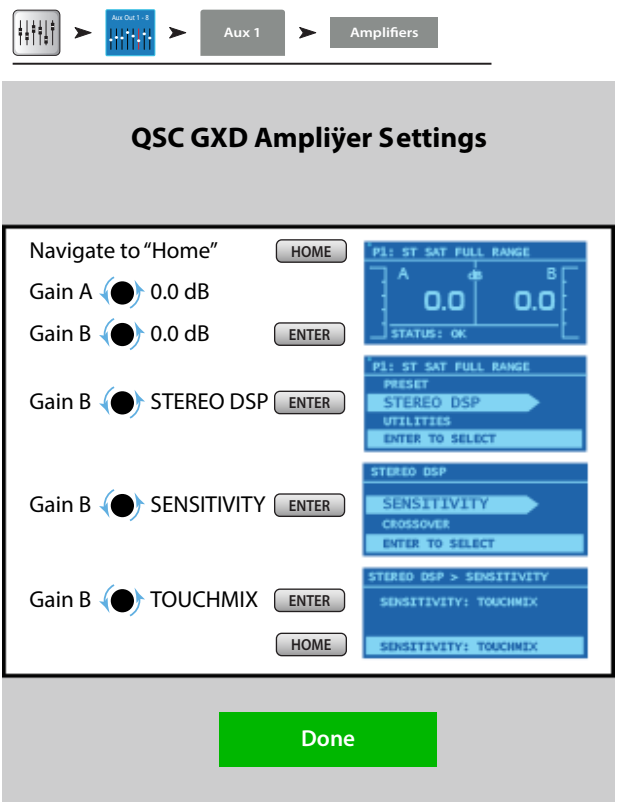

# Aux Overview

Provides an overview of all the Aux mixes.

Press Aux

The Aux Send and Output levels may be adjusted on screen or, for greater precision, by touching turning the Master Control or using the  $\wedge/\vee$  buttons on your tablet device.

(TouchMix-30 Pro only) When the Aux Overview is displayed, the Nav Strip display “grays out” the Aux Out 9-14 and DCA Groups miniature fader banks. This is because neither of these banks contains a signal that’s available on any auxiliary mix. See the Aux Mix on Faders topic for more information on Auxiliary and Matrix mixes.

1. **Input, FX Master and Sub Group** banks are selectable on the Nav Strip.
2. Each **column** (In 1, In 2) represents a channel, and displays the channel’s Aux Sends and pan controls.



**NOTE:** If an input has been given a name, the name will be displayed as the column heading. Touch the Select (name) button to navigate to the input channel’s controls.

3. Each **row** represents an **Aux mix**, the name of the mix is displayed in the first column and with the Master fader.
4. **Stereo Aux Master Slider** – A single slider is provided for a stereo linked Aux pair.
5. **Pan Control Slider** – Pans the input between the left and right sides of a stereo aux mix.
6. **Pre Fdr/ Post Fdr / Pre Dyn / Pre All** – Indicates the Aux Pick-off point that was set on the Aux Channel Setup tab.
7. **Aux Master Fader** – Adjusts the overall level of an Aux mix.



**NOTE:** User defined names display in the left column.



# Sub Groups (TouchMix-30 Pro only)

## Sub Group – Overview

Provides a single-screen view of frequently used controls and indicators for the Sub Groups.

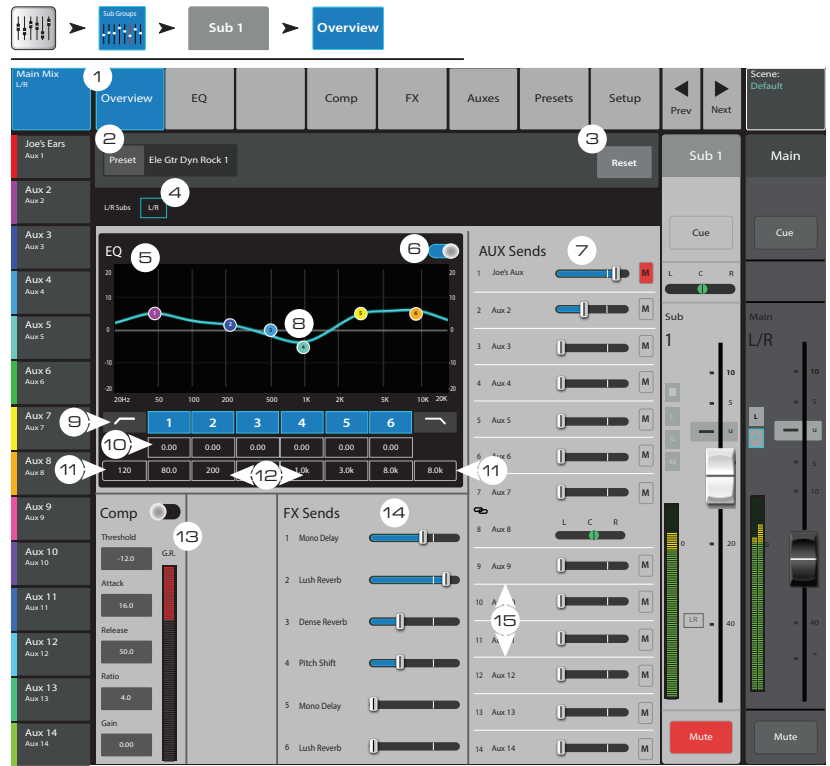

1. **Overview tab** – Selects the Sub Group Overview screen.
  2. **Preset** – Shows the currently selected Preset for this sub group. Cannot be changed from this screen.
  3. **Reset** – Sets all controls for the sub group to the factory default position.
  4. **L/R Subs** – Indicates whether or not the sub group is assigned to the Main output.
  5. **Parametric EQ Graph** – A graphic representation of the equalization curve based on the EQ settings. The trace dims to indicate that the EQ is Out (disengaged).
    - **EQ Graph Vertical Scale** – Represents audio level from -20 dB to +20 dB.
    - **EQ Graph Horizontal Scale** – Represents frequency from 20 Hz to 20 kHz.
  6. **EQ In** – Engages / disengages the equalizer for the sub group.
  7. **Aux Sends** –
    - Displays the system numbers and user-defined names for the Aux channels.
    - Adjustable sliders send signal to the associated Aux channel output.
    - **Mute** indicates if the channel's send to an Aux is muted or not.
  8. **EQ Handles** – Touch, hold, and drag to change the Frequency and Gain of the associated EQ band. The frequency band button must be engaged to see the EQ Handles.
  9. **Low and High Cut Filter** and **Frequency Bands 1, 2, 3, 4, 5, 6** – These buttons engage or disengage the associated filter.
- To adjust the following parameters, select the field then use the Master encoder or the up/down nudge buttons on a mobile device.
10. **Gain, Bands 1–6** – Displays and adjusts gain (+/- 15 dB) of the frequency band.
  11. **Low and High Cut Filter Frequency** – Displays and adjusts the knee frequency for the high and low cut filters.
  12. **Frequency Bands 1–6 frequency adjustment fields** – Displays and adjusts the center frequency for the four parametric EQ bands.
  13. **Comp** –
    - **Comp** – Engages or disengages the channel's dynamics processor.
    - **Threshold** – Displays and sets the level at which compression/limiting begins.
    - **Attack** – Displays and sets the time it takes for the compressor/limiter to reach its maximum compression when the threshold level is exceeded.
    - **Release** – Displays and sets the time it takes for the compressor/limiter to cease gain reduction when signal drops below threshold.
    - **Ratio** – Displays and sets the amount of compression applied to the signal.
    - **Gain** – Displays and sets the overall output gain to makeup any loss after the signal is compressed.
    - **G.R.** – Gain reduction meter shows the amount of compression applied to the signal.
  14. **FX Sends** –
    - Displays the system numbers and user-defined names for the FX channels.
    - Adjustable sliders send signal from this channel to the associated FX processors.
  15. **Aux Number & Name** – Displays the system numbers and user-defined names for the Aux mixes.



## Sub Group – PEQ (TouchMix -30 Pro only)

Controls and displays the settings for the Sub Group parametric equalization.

Press Home ➔ Touch a Sub Group Bank ➔ Touch a Sub Group ➔ Touch the EQ Tab

1. **EQ tab** — Selects the PEQ screen.
2. **PEQ In/Out switch** — Engages / disengages the equalizer.



**NOTE:** When the RTA is off, the Parametric EQ graph expands to use the entire graph area.

3. **RTA On button** — Turns the RTA (Real-time Analyzer) on and off.
4. **Simple button** — Hides the Low Cut, High Cut, Frequency, and BW controls. Does not effect existing settings.
5. **Reset button** — Sets all EQ controls to factory default values.
6. **RTA graph** — Displays the amplitude of the channel signal in 1/3 octave bands. Peak hold is displayed only on tablet devices.
7. **Parametric EQ graph** — A graphic representation of the equalization curve based on the EQ settings. The trace dims to indicate that the EQ is Out (disengaged).
  - **EQ graph vertical scale** — Represents audio level from -20 dB to +20 dB.
  - **EQ graph horizontal scale** — Represents frequency from 20 Hz to 20 kHz.
8. **EQ Handles** — Touch, hold, and drag to change the Frequency and Gain of the associated EQ band. The frequency band button must be engaged to see the EQ Handles.
9. **Low and High Cut Filter buttons** — These filters cut frequencies below or above the frequency set by the corresponding Freq control.
10. **Low and High Shelf Filter buttons** — Changes EQ Band 1 and Band 6 from parametric filters to shelving filters. When a shelf filter is engaged, the Bandwidth control is not available.
11. **Frequency Bands 1 - 6 In/Out** — Engages / disengages the associated parametric EQ band.
12. **Gain knob** — Adjusts and displays the gain at the frequency setting of the associated EQ band. Range of -15 dB to +15 dB.
13. **Freq knob** — Adjusts and displays the center frequency of the associated EQ band. The range is 20 Hz to 20 kHz for all bands. If the Shelving filter is engaged, the Freq control sets the knee frequency of the shelf filter.
14. **Q knob** — Adjusts the bandwidth of the associated EQ band. When the Shelf Filter is selected, the Bandwidth control is hidden. In addition to the Q knob, you can use a two-finger pinch / zoom to control the Q.
15. **Freq knob (Low and High Cut)** — Sets the knee frequency of the low and/or high cut filter as measured from a point 3 dB below 0 or unity.
16. **◀ ▶ buttons** — Navigates to the next or previous sub group. The buttons cycle through the Input, Playback, Record, and FX channels, then loops back to Input 1.
17. **Sub Group controls** — Output controls for selected Sub Group.
18. **Main Channel controls** — Output controls for the Main L/R outputs. See Channel Controls topic.

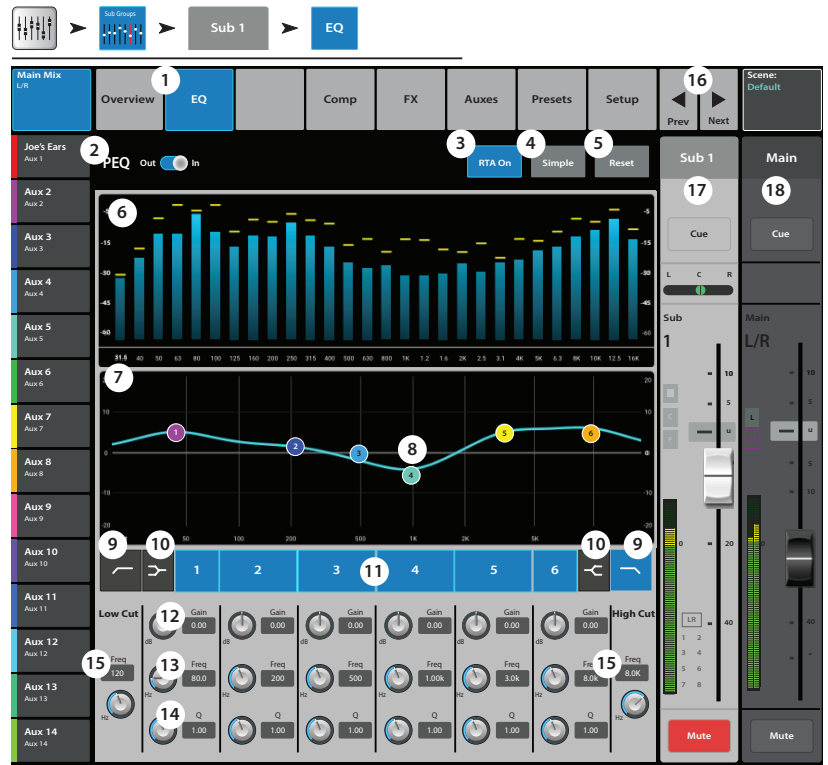

## Sub Group – Compressor / Limiter (TouchMix -30 Pro only)

The Compressor reduces the dynamic range of a signal above a set Threshold. When set as a Limiter, prevents the audio level from exceeding a pre-set threshold.



**NOTE:** Compressor and Limiter have similar controls. Some of the labels and the color of the trace will differ.

1. **Comp tab** – Selects the Compressor screen.
2. **Comp In / Out** – Engages and disengages the compressor.
3. **Comp / Limiter** – Changes the function of this screen between the Compressor and the Limiter.
4. **Knee In** – The knee determines whether the compressor/limiter transitions abruptly or gradually as the threshold is crossed.
 



Knee  
In      Out
5. **Simple** – Turns Simple mode on and off. Hides all controls except:
  - Comp (Limiter) In
  - Comp / Limiter
  - Simple
  - Reset
  - Compression (Limiting)
6. **Reset** – Sets all the Comp controls to their factory default position.
7. **In meter** – RMS input level
8. **G.R. meter** – Gain Reduction – (red) indicates how much the signal is being reduced by the compressor.
9. **Out meter** – Output level after any applied compression
10. **Threshold** – Sets the point at which the compressor will begin to reduce signal level.
11. **Compressor graph** – Vertical scale from 0 dB to -60 dB; horizontal measurement is time. When the Compressor is engaged, the trace is displayed.
  - **Threshold (A)** – The level at which compression begins.
  - **Attack time (B to C)** – The time it takes for the compression to reach maximum compression after the input exceeds the threshold level.
  - **Ratio (A to E)** – The amount of compression applied to the signal.
  - **Release time (C to D)** – The time it takes for the compressed signal to rise to the threshold level once the input level no longer exceeds the threshold.
12. **Ratio** – Sets the ratio of input level change to output level change when the signal exceeds the threshold.
13. **Attack** – Adjusts how quickly the compressor reacts to a signal that exceeds the threshold.
14. **Release** – Adjusts how quickly the compressor stops compressing when signal falls below threshold.
15. **Gain** – (Compressor only) Adjusts the overall output gain to makeup any loss after the signal is compressed.
16. **Compressor indicator** – When the Compressor is In, an orange “C” displays on the channel controls strip. The Limiter displays a blue “L”.



## Sub Groups – FX Sends (TouchMix -30 Pro only)

Controls how much of the Sub Group audio is sent to the FX devices.

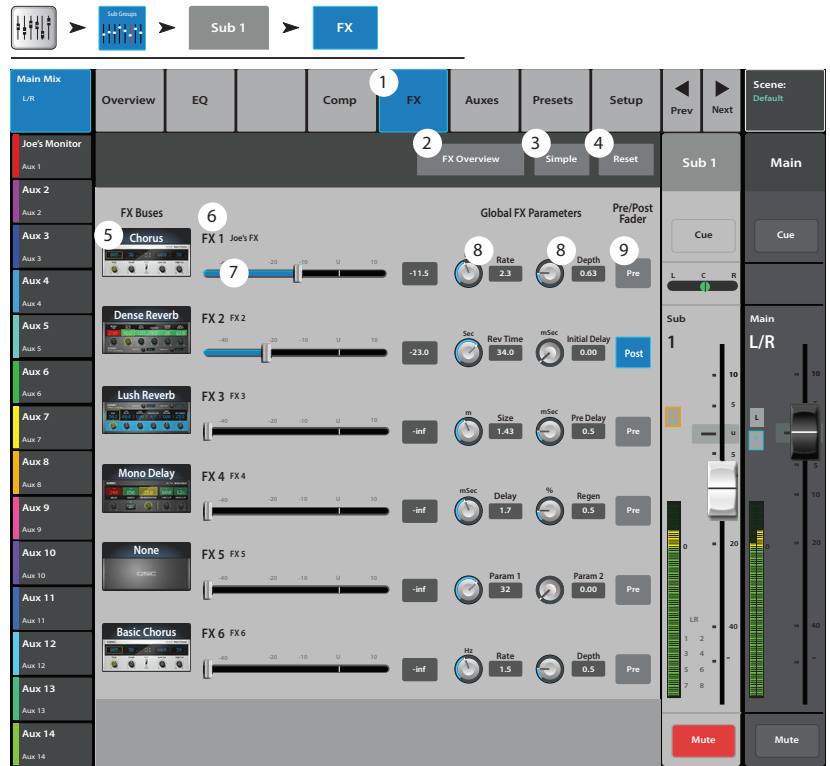

1. **FX tab** – Selects the FX Sends screen.
2. **FX Overview button** – Navigates to the FX Overview screen for a view of all 6 FX sends from all inputs.
3. **Simple** – Hides the Global FX Parameters for a simpler setup.
4. **Reset** – Resets the FX sliders, Pre/Post settings, and the Pitch Correct settings. This button does not reset the settings for the FX processors including the Global FX Parameters on this screen.
5. **FX Buses** – The icon indicates what processor has been selected for an FX mix. Touch the icon to navigate to the processor.
6. FX Label – The larger text identifies the FX bus 1 – 6, and does not change. The smaller text can be changed in the FX processor Setup screen.
7. FX Send sliders – Sets the level of audio “sent” from the channel to the FX mix; “-inf” is off. The digital read-out to the right of the slider indicates the slider setting.
8. **Global FX Parameters** – Provides control over the two most important parameters of the selected FX device. The controls are different depending on the selected processor.
9. **Pre/Post fader** – Selects a pre-fader or post-fader (default) pick-off point for the FX send. Changing this setting will change the pick-off for all inputs.

## Sub Group – Auxes (TouchMix -30 Pro only)

Sub Groups may be sent to Auxiliary Mixes. An Aux may be used to output a single Sub Group or as a matrix to mix multiple Sub Groups.

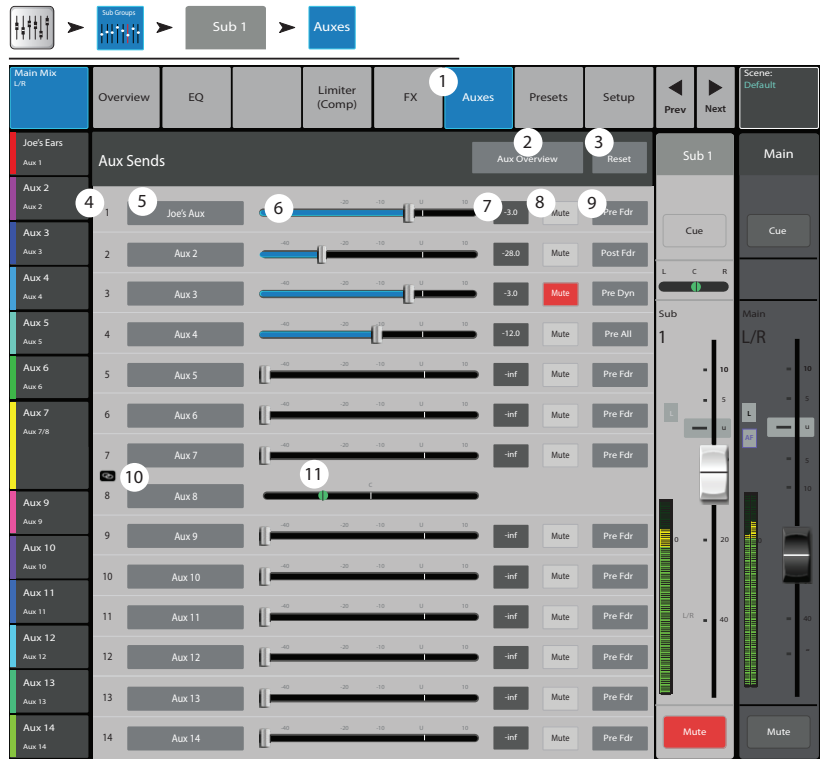

1. **Auxes tab** – Selects the Aux Sends screen
2. **Aux Overview** – Navigates to the Aux Overview which displays all Aux mixes on a single screen.
3. **Reset** – Resets all Aux Sends controls, for the selected input channel, to the factory default.
4. **Aux send system number** – Displays the number of the associated Aux Output.
5. **Aux Mix name** – Displays the Aux mix name. Touch to navigate to the associated Aux output controls.
6. **Aux send sliders** – Sets the level of audio sent from the channel to the Aux output; -40 dB (-Inf) is off.
7. **Gain readout** – Provides a numeric display of the Aux send level.
8. **Mute button** – Mutes the send from the channel to the associated Aux mix. Does not effect any other mixes.
9. **Pick-off point** – Indicates if the Aux Buss is taking a **Pre Fdr/ Post Fdr / Pre Dyn / Pre All** signal. Touch to navigate to the associated Aux output setup screen to change the setting.
10. **Aux link indicator** – Indicates the Aux channels are linked. Aux channels may be linked or unlinked from an Aux Output Setup screen.
11. **Aux sends pan-slider** – Pans the signal between a linked pair of auxes.

## Sub Group – Presets (TouchMix -30 Pro only)

Recall presets for the selected Sub Group channel.



1. **Presets tab** – Selects the Presets screen.

2. **Current Preset** – Displays the name of the currently active preset (if any).

3. **Save / Save As button** – Displays a page with options for naming a scene and selecting internal or USB storage destination.

4. **Factory list** – Displays a list of the factory programmed presets available for the sub group.

5. **Mixer (internal) list** – Displays a list of presets that have been stored to Internal mixer memory.

6. **USB (external) list** – Displays a list of presets that have been saved on an External (USB) drive.

7. **Delete button** – Deletes a selected preset from Internal or External user memory.

8. **Copy to USB button** – Copies the selected preset to an external USB Drive.

9. **Copy to Mixer button** – Copies the selected preset to the internal mixer memory.

10. **Recall button** – Recalls the selected preset.

11. **Omit Levels switch** – When Omit Levels is On, recalling a preset will not affect any Sub Group levels.

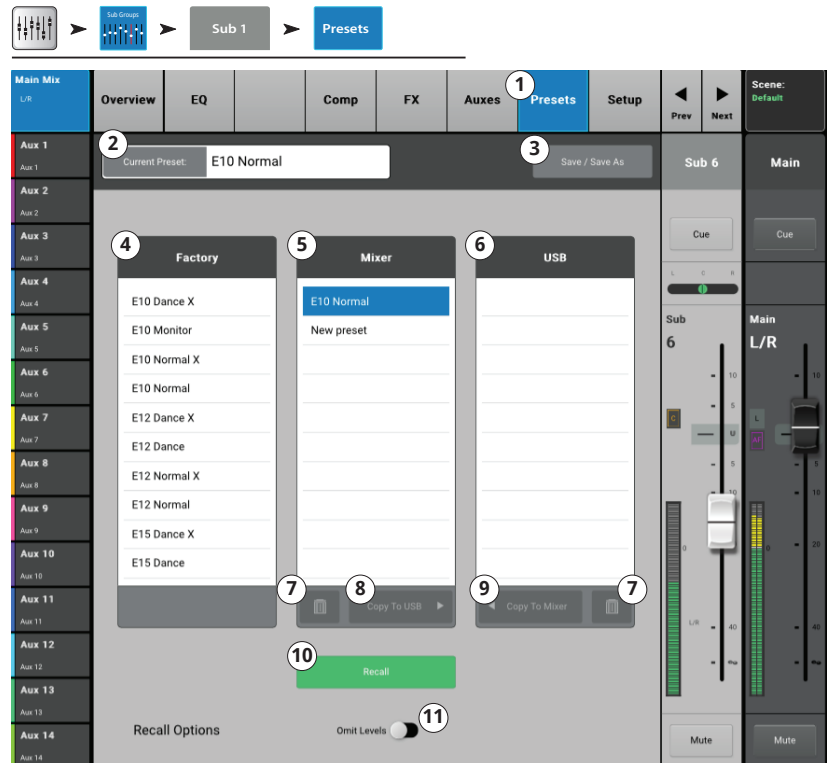



## Sub Group – Setup (TouchMix -30 Pro only)

Rename the Sub Channel, assign Input channels to the group, and assign/unassign the group to the Main L/R.

Press Menu ➔ Touch FX Masters ➔ Touch an FX Channel ➔ Touch Setup



1. **Setup tab** – Selects the Sub Group Setup screen.
2. **Name** – Touch the Name to display a keyboard that may be used to enter a name for the channel.
3. **Link** – Touch the Link button to link the channel with the adjacent channel. Always links odd to even.
4. **Reset** – Returns settings to the factory default.
5. **No/Yes** – Select “Yes” to automatically unassign an input channel from the Main L/R when it is assigned to the Sub Group.
6. Input Channel numbering, both system (1) and user assigned (In 1).
7. **L/R assigned**  – Indicates the Sub Group is assigned to the Main L/R outputs.
8. **L/R unassigned**  – Indicates the Sub Group is not assigned to the Main L/R outputs.
9. **Main L/R assignment button** – Assigns and unassigns this Sub Group to the Main L/R outputs.

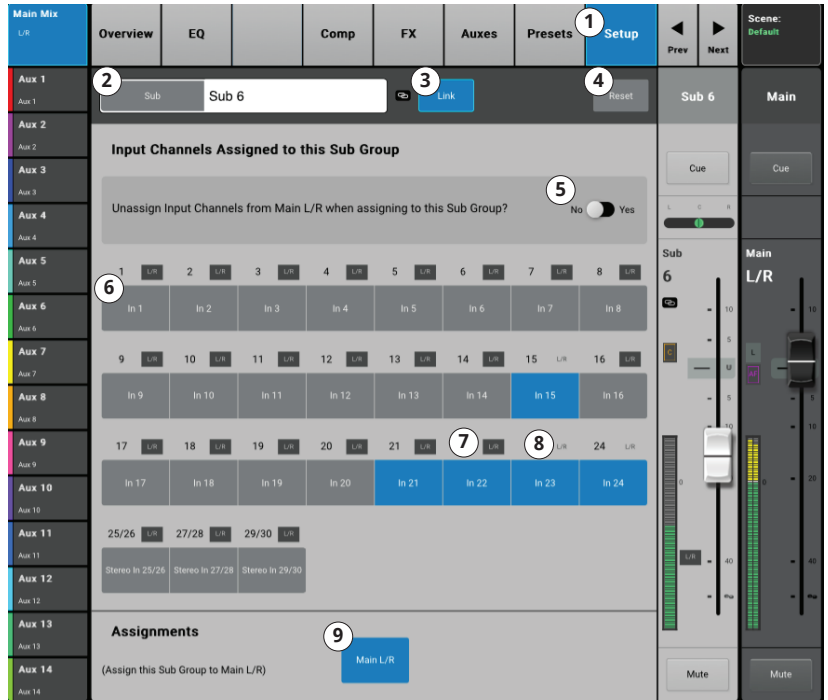

# 2-Trk Playback

2-Track playback controls a digital, stereo audio input signal. Depending on the Recording Mode selected, this signal may be from a USB multi-track session, a DAW (TouchMix-30 Pro only) or from MP3 files stored on the root directory of a USB drive.

## 2-Trk Playback – Overview

Provides a single-screen view of frequently used controls and indicators for the MP3 Audio Player and the 2-Track PB channel. The settings made here affect both MP3 and 2-Track audio.

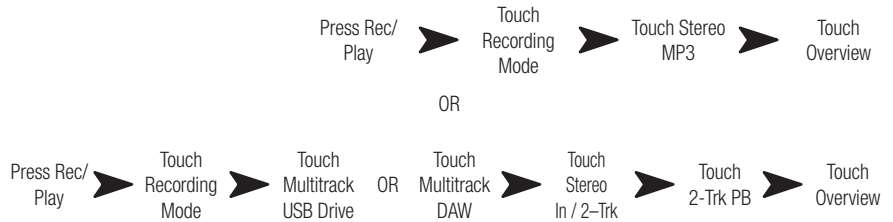

1. **Overview tab** – Selects the Channel Overview screen.
2. **Preset** – Shows the currently selected Preset for this channel. Touch + to change the Preset.
3. **Reset button** – Sets all controls for the playback channel to the factory default position.
4. **Assigned To** – Indicates the output assignment channel L/R Main or not. Change in Setup.
5. **Parametric EQ graph** – A graphic representation of the equalization curve based on the EQ settings. The trace dims to indicate that the EQ is Out (disengaged).
  - **EQ Graph vertical scale** – Represents audio level from -20 dB to +20 dB.
  - **EQ Graph horizontal scale** – Represents frequency from 20 Hz to 20 kHz.
6. **Out/In** – Engages / disengages the equalizer for the MP3 and 2-Track PB channel.
7. **EQ Handles** – Touch, hold, and drag to change the Frequency and Gain of the associated EQ band. The frequency band button must be engaged to see the EQ Handles.
8. **Mute** – Indicates the Mute groups to which this channel is assigned.
9. **Aux Sends** –
  - Displays the system numbers and user-defined names for the Aux channels.
  - Adjustable sliders send signal to the associated Aux channel output.
  - Mute indicates if the channel’s send to an Aux is muted or not.
10. **Low Cut Filter and Shelf Filters 1 and 2** buttons – These buttons engage or disengage the associated filter.



**NOTE:** To adjust the following parameters, select the field then use the Master encoder or the up/down nudge buttons on a mobile device.

11. **Frequency, Low-Cut Filter** – Displays and adjusts the knee frequency for the low cut filter.
12. **Gain, Shelf Filters 1 and 2** – Displays and adjusts gain (+/- 15 dB) of the shelf filter.
13. **Frequency, Shelf Filters 1 and 2** – Displays and adjusts the frequency for both shelf filters.
14. **Aux number & name** – Displays the system numbers and user-defined names for the Aux mixes.
15. **M** – Indicates if the FX channel send to the Aux mix is muted. You can change this in the FX Masters Auxes tab.

## 2-Trk PB – EQ

2-Trk PB (2-track playback) provides equalization for 2-Track audio from a previous TouchMix session or MP3 files stored on a USB device.

1. **EQ tab** – Displays the Audio Player EQ controls.
2. **PEQ switch** – Enables (In) / bypasses (Out) the equalizer.
3. **RTA On** – Enables / disables the Real Time Analyzer.



**NOTE:** A maximum of two RTA displays for TouchMix-30 Pro, and one RTA display for the TouchMix-8 and -16 are available at a time on any combination of a mixer and tablet devices.



**NOTE:** When the RTA is off, the Parametric EQ graph expands to use the entire graph area.

4. **Reset button** – Sets all the EQ controls to their factory default position.
5. **RTA Display** – Displays the amplitude of the channel signal in 1/3 octave bands.



**NOTE:** Peak hold is displayed only on tablet devices.

6. **EQ graph** – A graphic representation of the EQ settings.
7. **EQ Handles** – Touch, hold, and drag to change the Frequency and Gain of the associated EQ band. The frequency band button must be engaged to see the EQ Handles.
8. **Low Cut filter button** – This filter cuts frequencies below the frequency set by the corresponding Freq control.
9. **Bands 1 & 2 button** – Engages / disables the low and high shelf filters.
10. **Gain knob** – Adjusts the gain of the associated shelf filter over a range of -15 dB to +15 dB.
11. **Frequency knob** – Sets the center, or shelving, frequency of the associated EQ band.

The screenshot shows the TouchMix software interface with the EQ control panel. The interface includes a top navigation bar with tabs for Overview, EQ, Audio Player, Auxes, Presets, and Setup. The EQ tab is active, showing a parametric EQ graph with 11 frequency bands. The graph has a frequency axis from 20Hz to 20KHz and a gain axis from -15 to +15 dB. The EQ handles for each band are visible, showing frequency and gain values. The interface also includes a 'Low Cut' filter button, 'Bands 1 & 2' buttons, and gain/frequency knobs for each band. The background shows a mix console with various channels and meters.



## 2-Trk Playback – Audio Player

Plays MP3 audio files from a USB memory device.



**NOTE:** Make sure the Sample Rate set in the Mixer Setup matches the sample rate of the MP3 file.

1. **Audio Player tab** – touch to display Audio Player controls.
2. **MP3 Songs** – Displays a list of MP3 titles on the inserted USB drive.
3. **MP3** – Displays title of currently selected MP3 file.
4. **Top-of-List** – Touch to move to the beginning of the file list.
5. **Previous file** – Touch to move to the previous file in the file list.
6. **Play** – Touch to begin playback of the currently selected MP3 file.
7. **Next file** – Touch to move to the next file in the file list.
8. **Stop Play** – Touch to stop playback of the currently selected MP3 file.
9. **Playback Time** – Indicates elapsed time since beginning playback.
10. **Recording Mode** – Touch to change from MP3 Playback mode to either Multitrack USB Drive or Multitrack DAW.
11. **00:00:00** – Represents the start of the file.
12. **Progress Line** indicates the approximate playback position in the file.
13. **HH:MM:SS** – Indicates the length of the file.

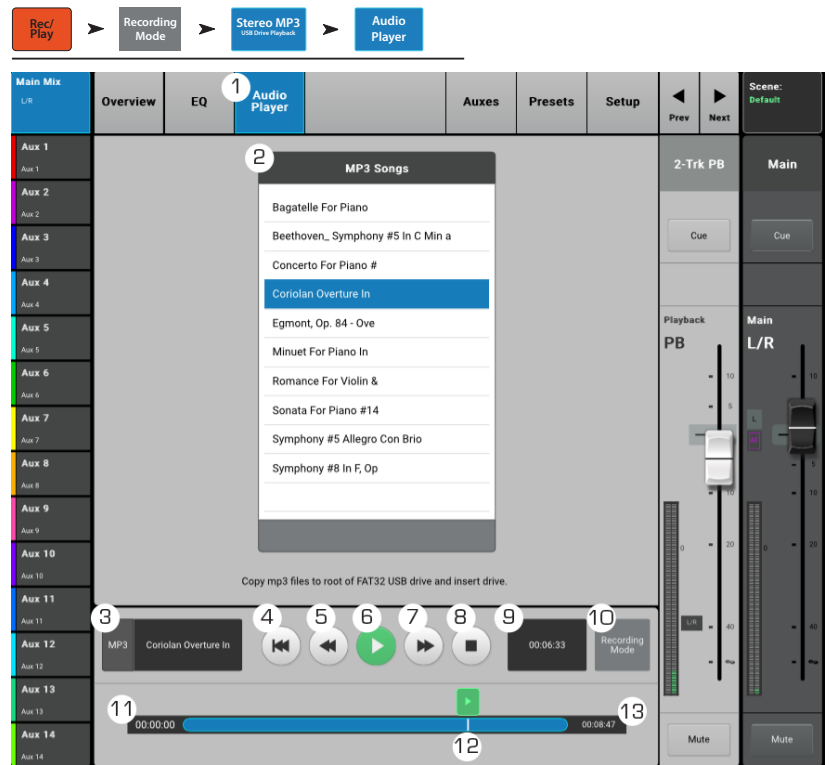

## 2-Trk Playback – Auxes

Auxiliary outputs are used to create a mix for stage monitors, in ear monitors, remote speakers or video / broadcast.

1. **Auxes tab** – Selects the Aux Sends screen
2. **Aux Overview button** – Navigates to the Aux Overview which displays all Aux mixes on a single screen.
3. **Reset button** – Resets all Aux Sends controls, for the selected input channel, to the factory default.
4. **Aux send system number** – Displays the number of the associated Aux Output.
5. **Aux master name** – Displays the Aux mix name. Touch to navigate to the associated Aux output controls.
6. **Aux send sliders** – Sets the level of audio sent from the channel to the Aux output; -40 dB (-Inf) is off.
7. **Gain** – Provides a numeric display of the Aux send level.
8. **Mute** – Mutes the send from the channel to the associated Aux mix. Does not effect any other mixes.
9. **Pick-off point** – Indicates if the Aux Buss is taking a **Pre Fdr / Post Fdr / Pre Dyn / Pre All signal**. Touch to navigate to the associated Aux output controls to change the setting.
10. **Aux link indicator** – Indicates the Aux channels are linked. You can link Aux channels from an Input channel Aux Sends screen by touching one of the Aux Master buttons, or one of the pick-off buttons. Both take you to the Aux channel Setup screen where linking is accomplished.
11. **Aux sends pan slider** – Pans the signal between a linked pair of auxes.

The diagram illustrates two navigation paths for 2-Trk Playback:

- Path 1:** Press Rec/Play → Touch Recording Mode → Touch Stereo MP3 → Touch Auxes
- Path 2:** Press Rec/Play → Touch Recording Mode → Touch Multitrack USB Drive OR Touch Multitrack DAW → Touch Stereo In / 2-Trk → Touch 2-Trk PB → Touch Auxes

Below the paths are two simplified flowcharts:

- Flowchart 1:** Rec/Play → Recording Mode → Stereo MP3 (USB Drive Playback) → Auxes
- Flowchart 2:** Rec/Play → Recording Mode → Multitrack (USB Drive) OR Multitrack (DAW) → Stereo In/2-Trk → 2-Trk PB → Auxes

The screenshot shows the 'Auxes' screen with 14 Aux channels. Numbered callouts (1-11) point to specific UI elements: 1 (Auxes tab), 2 (Aux Overview button), 3 (Reset button), 4 (Aux system number), 5 (Aux master name), 6 (Aux send slider), 7 (Gain display), 8 (Mute button), 9 (Pick-off point), 10 (Aux link indicator), and 11 (Aux sends pan slider).

## 2-Trk Playback – Presets

Recall presets for the MP3 Stereo and the 2-Trk Playback.

1. **Presets tab** – Selects the Presets screen.
2. **Current Preset** – Displays the name of the currently active preset (if any).
3. **Save / Save As button** – Displays a page with options for naming a scene and selecting internal or USB storage destination.
4. **Factory list** – Displays a list of the factory programmed presets available for the currently loaded FX device. Touch a preset name to select.
5. **Mixer (internal) list** – Displays a list of presets that have been stored to mixer's internal memory.
6. **USB (external) list** – Displays a list of presets that have been saved on an external (USB) drive.
7. **Delete button** – Deletes a selected preset from the mixer or USB user memory.
8. **Copy to USB button** – Copies the selected preset to an external USB Drive.
9. **Copy to Mixer button** – Copies the selected preset to the internal mixer memory.
10. **Recall button** – Recalls the playback parameters of the selected preset. Recall affects Aux Sends, EQ, Mutes, and Group assignments.
11. **Omit Levels** – When on, the Aux and 2-Trk PB fader levels are not affected by the preset Recall. EQ levels are affected by the Recall in either position.

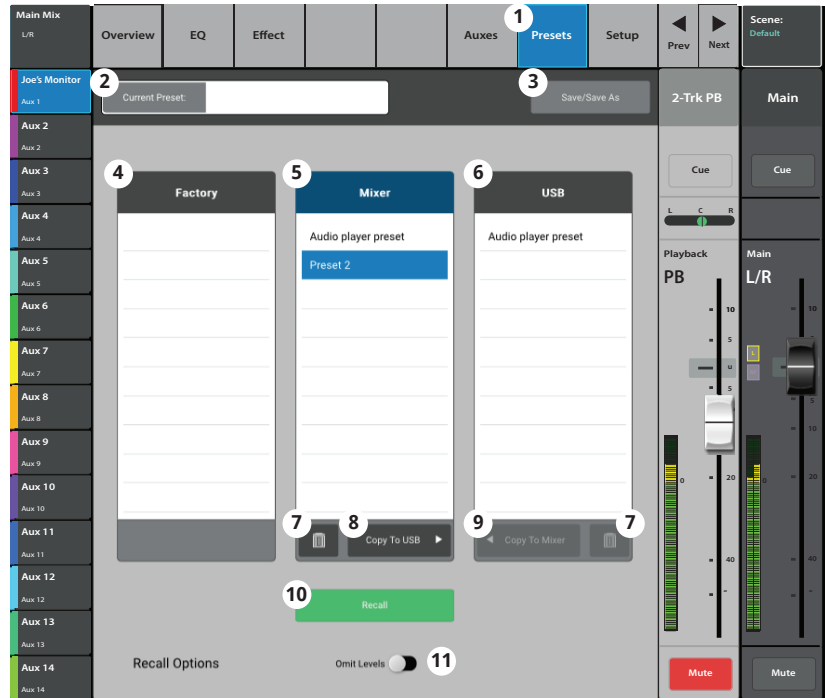
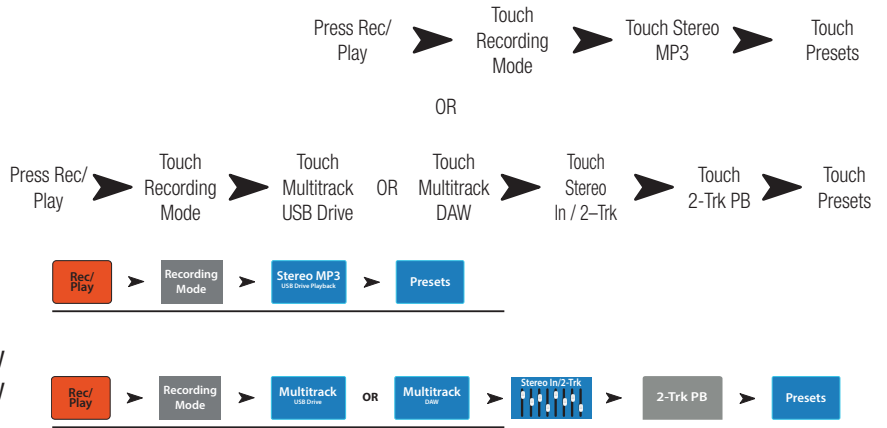

## 2-Trk Playback - Setup

Rename the 2-Trk PB channel, set Channel Safe, and assign the channel to Mute and DCA Groups

1. **Setup tab** – Selects the Setup screen.
2. **Name field** – Touch the Name to display a keyboard that may be used to enter a name for the channel.
3. **Reset button** – Returns settings to the factory default.
4. **Channel Safe During Scene Recall** – Setting this switch to Safe prevents channel settings from being changed when a Scene is recalled.
5. **Main L/R button** – Turns the FX channel's assignment to the Main Left / Right output on and off.
6. **DCA Group Assignment Buttons** – Select the DCA Groups this channel is to be part of. See the DCA Groups topic.
7. **Mute Group Assignment Buttons** – Select the Mute Groups this channel is to be part of. See the Mute Groups topic.

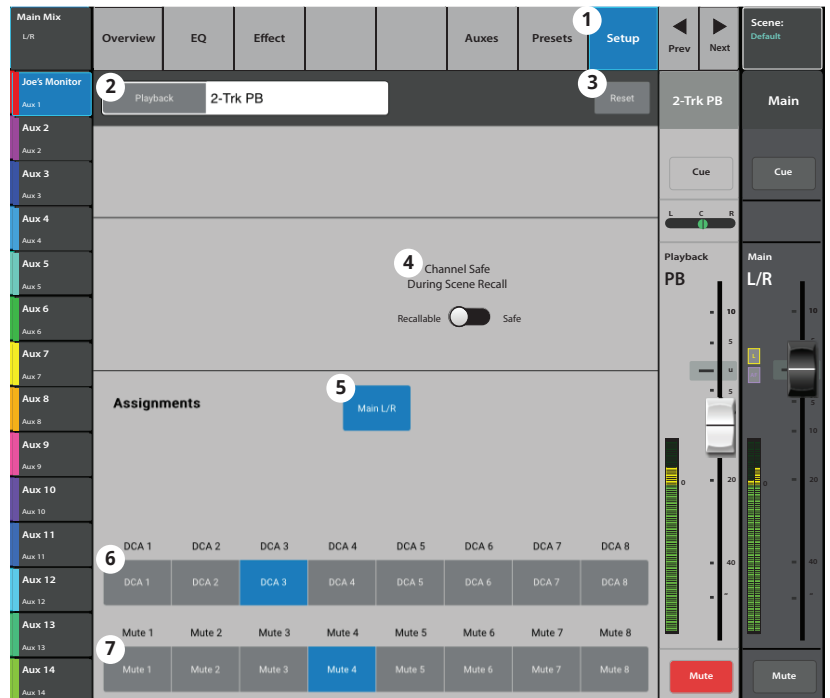
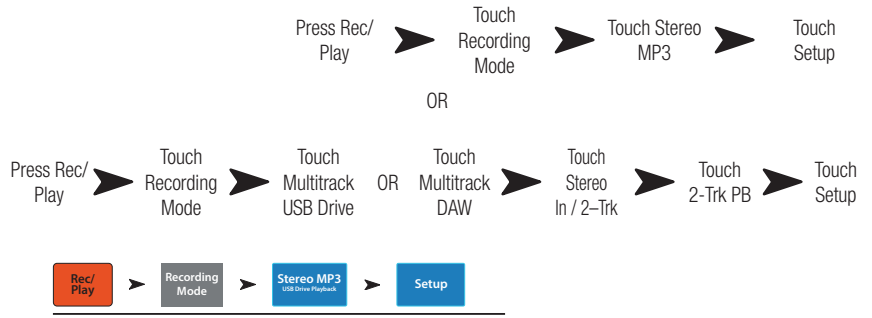

## 2-Trk / Multitrack Playback

Multitrack mode plays back audio recorded on the USB drive. Multitrack DAW mode (TouchMix-30 Pro only) plays back tracks from a Core Audio compliant computer.

2-Track Playback plays files that have been recorded from the 2-Trk Record channel. If recording is stopped and resumed, a new .wav file is created. The files in a session / directory are concatenated for seamless playback.

1. **Stereo In/2-Trk bank** – touch to display 2-Trk PB channel and controls.
2. **2-Trk PB select button** – Touch to access details of the channel.
3. **USB Session** – Displays title of active session.
4. **Start of session button** – Touch to move to the beginning of the session.
5. **Rewind button** – Touch to move quickly through the file towards the beginning of the session.
6. **Play button** – Touch to begin playback of the currently selected USB Session. Playback starts at the location of the Progress marker (16).
7. **Fast Forward button** – Touch to move quickly through the file towards the end of the session.
8. **Stop button** – Touch to stop playback of the current session.
9. **Record button** – Touch to begin recording in the current session. Records all armed channels.
10. **Playback Time Display** – Indicates elapsed time since beginning playback.
11. **Recording Mode** – Touch to change from the MP3 Playback mode to either Multitrack USB Drive or Multitrack DAW (DAW available on TouchMix-30 Pro only).
12. **Set button** – Touch to set the current spot, in the session, of the Loc (location) marker.
13. **Go To button** – Touch to move the Progress Marker to the spot indicated by the Loc marker.
14. **00:00:00** – Represents the start of the file.
15. **Loc marker** – Touch and drag the Loc (location) marker to a spot in the file you want, then touch the Set button to set the location.
16. **Progress marker** – Indicates the current playback position in the current session. Touch and drag to a spot in the file you want.
17. **HH:MM:SS** – Indicates the length of the session.
18. **Recording Setup** – displays the controls for 2-Trk Recording. Refer to the topic.FX Masters

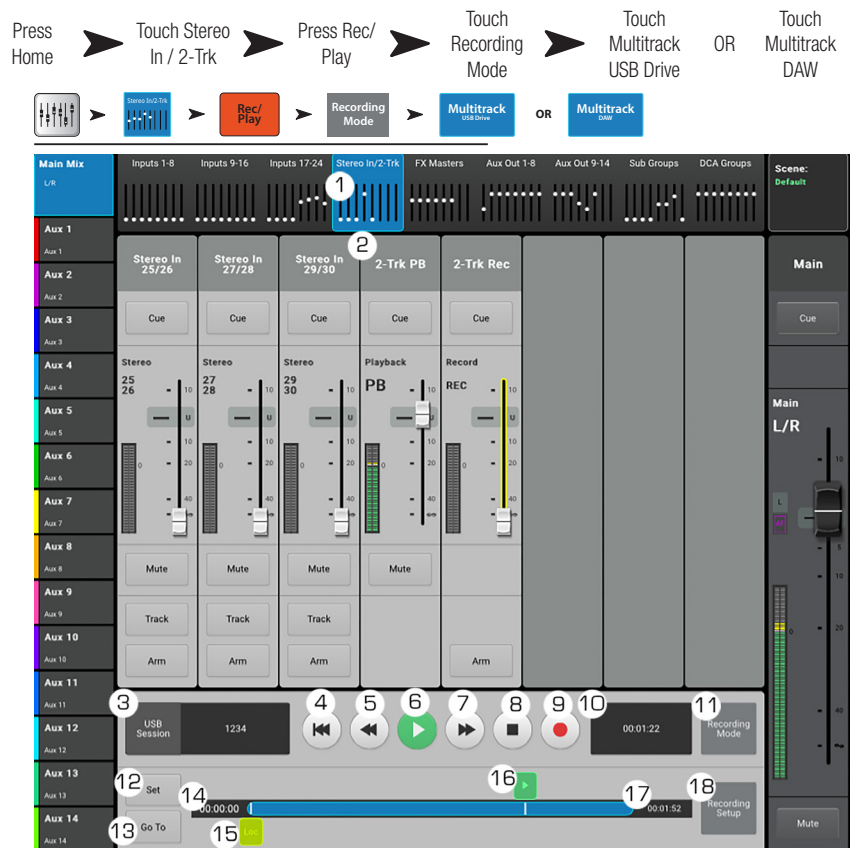

# FX Masters

## FX Master – Overview

Provides a single-screen view of frequently used controls and indicators for the FX channel.



1. **Overview tab** – Selects the Channel Overview screen.
2. **Preset** – Shows the currently selected Preset for this channel. Touch the + to change.
3. **Effect** – Shows the currently selected Effect type for this channel. Touch the + to change.
4. **Pre Fader / Post Fader button** – Selects the Aux mix pick-off point for the effect. Selections are: Pre Fader – before the FX master fader, or Post Fader – after the FX master fader.
5. **Reset button** – Sets all controls for the FX channel to the factory default position.
6. **Assigned To** – Indicates the output assignments channel (L/R Main, Sub Groups 1 - 8).
7. **DCA** – Indicates the DCA groups to which this channel is assigned.
8. **Mute** – Indicates the Mute groups to which this channel is assigned.
9. **Parametric EQ graph** – A graphic representation of the equalization curve based on the EQ settings. The trace dims to indicate that the EQ is Out (disengaged).

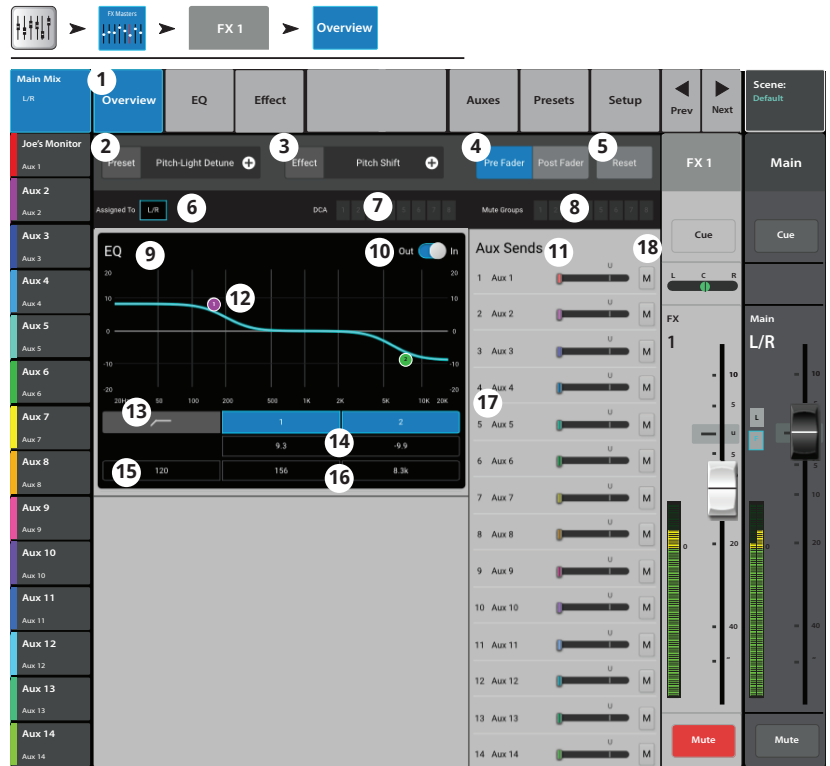

- **EQ Graph vertical scale** – Represents audio level from -20 dB to +20 dB.
  - **EQ Graph horizontal scale** – Represents frequency from 20 Hz to 20 kHz.
10. **EQ Out/In** – Engages / disengages the equalizer for the FX channel.
  11. **Aux Sends** –
    - Displays the system numbers and user-defined names for the Aux channels.
    - Adjustable sliders send signal to the associated Aux channel output.
    - Mute indicates if the channel’s send to an Aux is muted or not.
  12. **EQ Handles** – Touch, hold, and drag to change the Frequency and Gain of the associated EQ band. The frequency band button must be engaged to see the EQ Handles.
  13. **Low Cut Filter** and **Shelf filters 1 and 2** – These buttons engage or disengage the associated filter.



**NOTE:** To adjust the following parameters, select the field then use the Master encoder or the up/down nudge buttons on a mobile device.

14. **Gain, shelf filters 1 and 2** – Displays and adjusts gain (+/- 15 dB) of the frequency band.
15. **Low-Cut filter frequency** – Displays and adjusts the knee frequency for the high and low cut filters.
16. **Shelf filters 1 and 2 frequency adjustment fields** – Displays and adjusts the center frequency for both parametric EQ bands.
17. **Aux number & name** – Displays the system numbers and user-defined names for the Aux mixes.
18. **M** – Indicates if the FX channel send to the Aux mix is muted. You can change this in the FX Masters Auxes tab.

# FX Masters – EQ

Controls and displays the settings for the FX Master channel equalization.



1. **EQ Tab** – Selects the FX Master EQ screen.
2. **EQ In/Out** – Engages / bypasses the equalizer.
3. **RTA On** – Enables the Real Time Analyzer.
4. **Reset** – Sets the equalizer to factory default (flat).
5. **RTA** – 1/3 octave Real Time Analyzer display of the post-EQ signal.



**NOTE:** A maximum of two RTA displays are available at a time on any combination of a mixer and tablet devices.



**NOTE:** When the RTA is off, the Parametric EQ graph expands to use the entire graph area.

6. **EQ Graph** – A graphic representation of the EQ settings. The vertical measurement is gain, the horizontal is frequency.
7. **EQ Handles** – Touch, hold, and drag to change the Frequency and Gain of the associated EQ band. The frequency band button must be engaged to see the EQ Handles.
8. **Low Cut** – Adjusts the low cut (high pass) filter frequency.
9. **Shelf Filter Buttons** – Engages / bypasses the individual shelf filters.
10. **Gain** – Adjusts the gain of the associated shelf filter over a range of -15 dB to +15 dB.
11. **Freq** – Sets the frequency of the associated shelf filter.

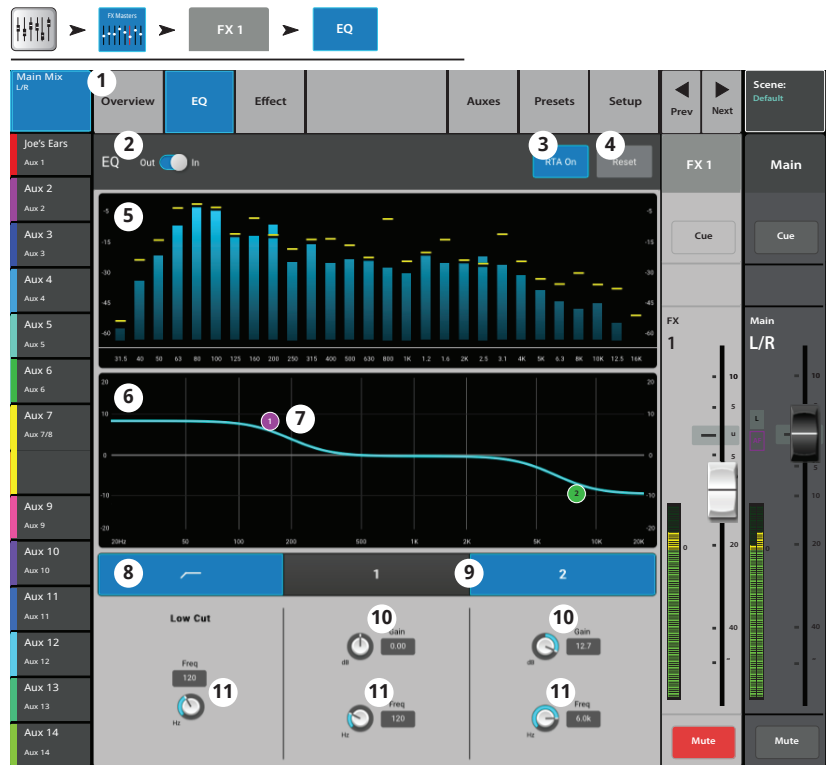

# FX Masters - Presets

Recall presets for the selected FX channel based on the current FX device.



1. **Presets tab** – Selects the Presets screen.
2. **Current Preset** – Displays the name of the currently active preset (if any).
3. **Save / Save As button** – Displays a page with options for naming a scene and selecting internal or USB storage destination.
4. **Factory list** – Displays a list of the factory programmed presets available for the currently loaded FX device. Touch a preset name to select.
5. **Mixer (internal) list** – Displays a list of presets that have been stored to Internal mixer memory.
6. **USB (external) list** – Displays a list of presets that have been saved on an External (USB) drive.
7. **Delete button** – Deletes a selected preset from Internal or External user memory.
8. **Copy to USB button** – Copies the selected preset to an external USB Drive.
9. **Copy to Mixer button** – Copies the selected preset to the internal mixer memory.
10. **Recall button** – Recalls the effects parameters of a preset selected in the Factory, Mixer or USB list. Recall does not affect Aux Sends, EQ, Mutes, or Group assignments.

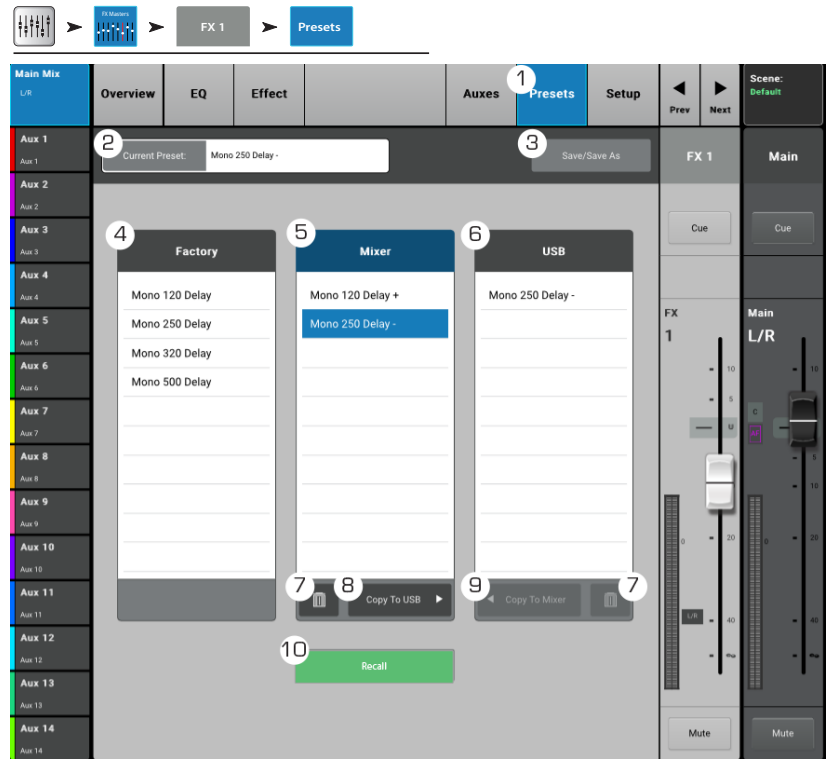



# FX Master – Setup

Rename the FX Master channel, and assign the channel to Mute and DCA Groups



1. **Setup tab** – Selects the Setup screen.
2. **Name field** – Touch to display a keyboard and enter a name for the channel.
3. **Reset button** – Returns settings to the factory default.
4. **Effect Pick-Off** – Selects a pre or post-fader pick-off point for the effect send.
5. **Main L/R button** – Turns the FX channel’s assignment to the Main Left / Right output on and off.
6. **DCA Group Assignment Buttons** – Select the DCA Groups this channel is to be part of. See the DCA Groups topic.
7. **Mute Group Assignment Buttons** – Select the Mute Groups this channel is to be part of. See the Mute Groups topic.

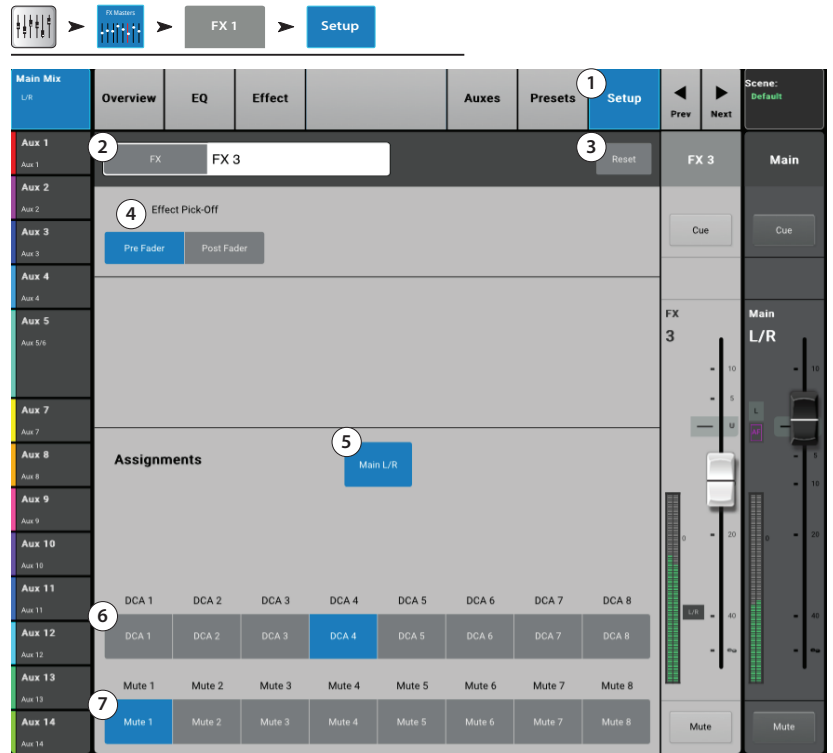

# FX Master – Auxes

These sends allow the effect to be returned to mixes for stage monitors, in ear monitors, remote speakers or video / broadcast.

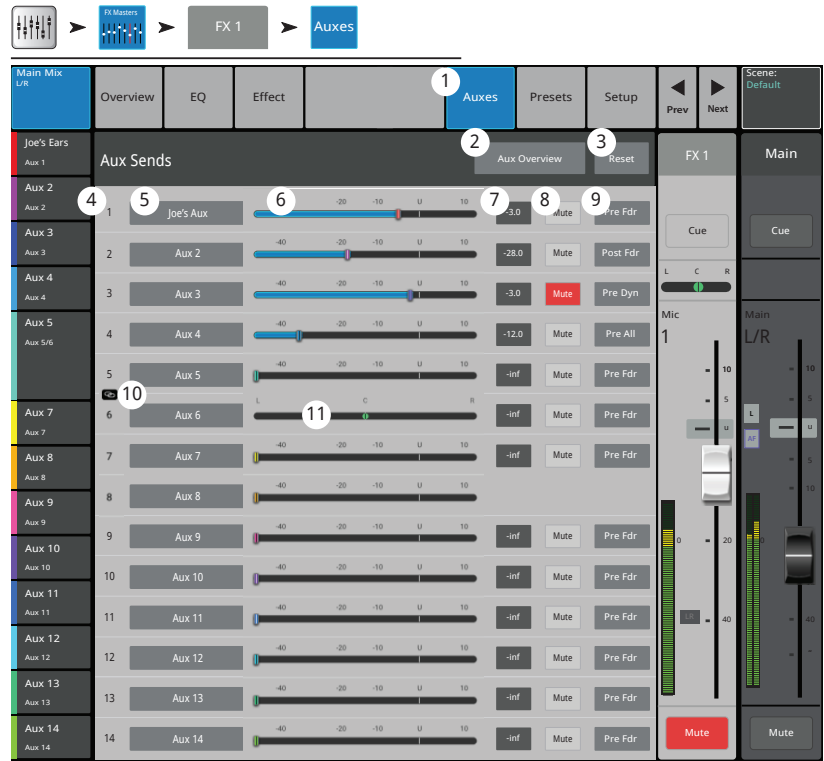

1. **Auxes tab** – Selects the Aux Sends screen
2. **Aux Overview button** – Navigates to the Aux Overview which displays all Aux mixes on a single screen.
3. **Reset button** – Resets all Aux Sends controls, for the selected input channel, to the factory default.
4. **Aux send system number** – Displays the number of the associated Aux Output.
5. **Aux Mix name** – Displays the Aux mix name. Touch to navigate to the associated Aux output controls.
6. **Aux send sliders** – Set the level of audio sent from the channel to the Aux output; -40 dB (-Inf) is off. Sliders are color coded.
7. **Gain readout** – Provides a numeric display of the Aux send level.
8. **Mute button** – Mutes the send from the channel to the associated Aux mix. Does not effect any other mixes.
9. **Pick-off point button** – Indicates if the Aux Buss is taking a **Pre Fdr/ Post Fdr / Pre Dyn / Pre All signal**. Touch to navigate to the associated Aux output setup screen to change the setting.
10. **Aux link indicator** – Indicates the Aux channels are linked. You can link Aux channels from an Input channel Aux Sends screen by touching one of the Aux Master buttons, or one of the pick-off buttons. Both take you to the Aux channel Setup screen where linking is accomplished.
11. **Aux sends pan-slider** – Pans the signal between a linked pair of auxes.

# FX Overview

Provides an overview of the channel FX Send and Return levels.

FX sends and FX Master levels may be adjusted by touching (selecting) the control then using the Master Encoder or the Nudge buttons on a tablet device.

Press Menu  Touch FX Overview

## FX Overview Screen



**NOTE:** Only **Input** and **Sub Group** banks are selectable on the Nav Strip.

1. Select an Input or Sub Group bank.
2. Each column (In 1, In 2 ...) represents a channel, and lists the channel's six FX Sends.
3. Each row represents an FX mix, and lists the FX Sends for the mix.
4. **FX Master fader** – Adjusts the overall level of the effect that will be heard in the mix.
5. **FX Processor Icon** – Indicates the currently selected FX device for the FX mix.

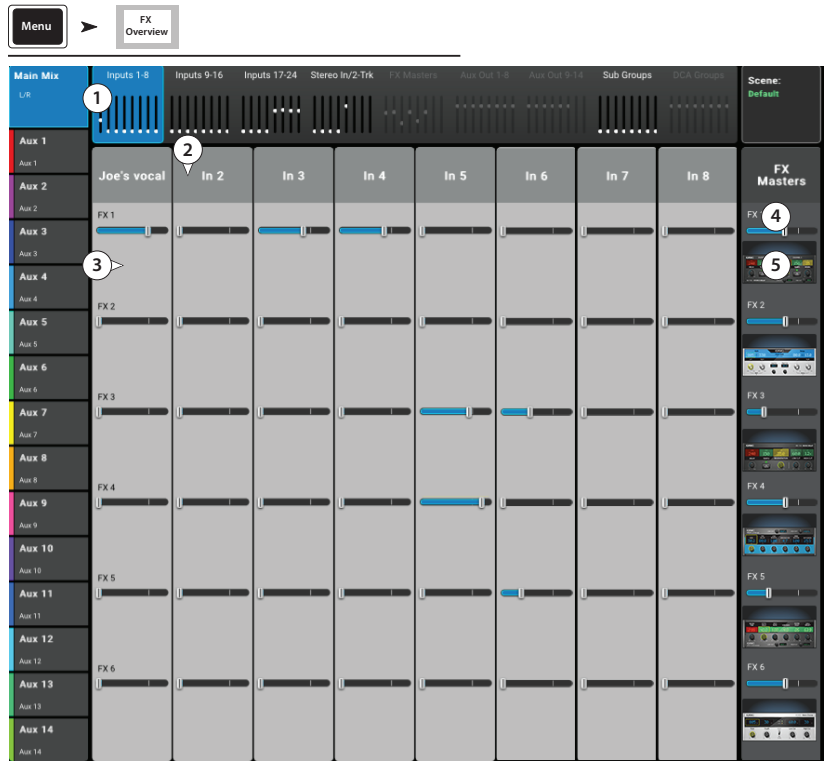

# Wizards

## FX Wizard

The FX Wizard aids in selecting and routing effects.

Press Wizard  Touch FX Wizard

1. **FX1 - 6 tabs** – Selects one of six FX processors. (Four on TouchMix-8 and TouchMix-16)



**NOTE:** The Source, Type, and FX Preset windows provide a means of selecting an Effect based on what the source is. If any of the lists fill the window, flick up on the list to show more selections.

2. **Source list** – Use the Source window to select the source instrument category.
3. **Type list** – Use the Type windows to select the specific type of instrument. This narrows the selection to a list of recommended presets appropriate for the application.
4. **FX Preset list** – Use the FX Preset window to select the Effect and variation. For example, in the FX Preset window the letter “D” refers to the Dense Reverb Effect, and the text following the letter indicates the Preset (variation) of the Dense Reverb.
5. **Recall button** – Loads selected effect.
6. **Clear button** – Unassigns all the inputs and outputs.
7. **Select inputs to feed**  **Label** – Each input channel is represented by a button. Touch one or more of these buttons to apply the effect to an input.
8. **Cue button** – Touch Cue above the FX fader to hear the output of the selected effect on the Cue system.
9. **Select Aux Output buttons** – Each Aux Output is represented by a button. Touch one or more of these buttons to send the effect to the associated Aux Output.

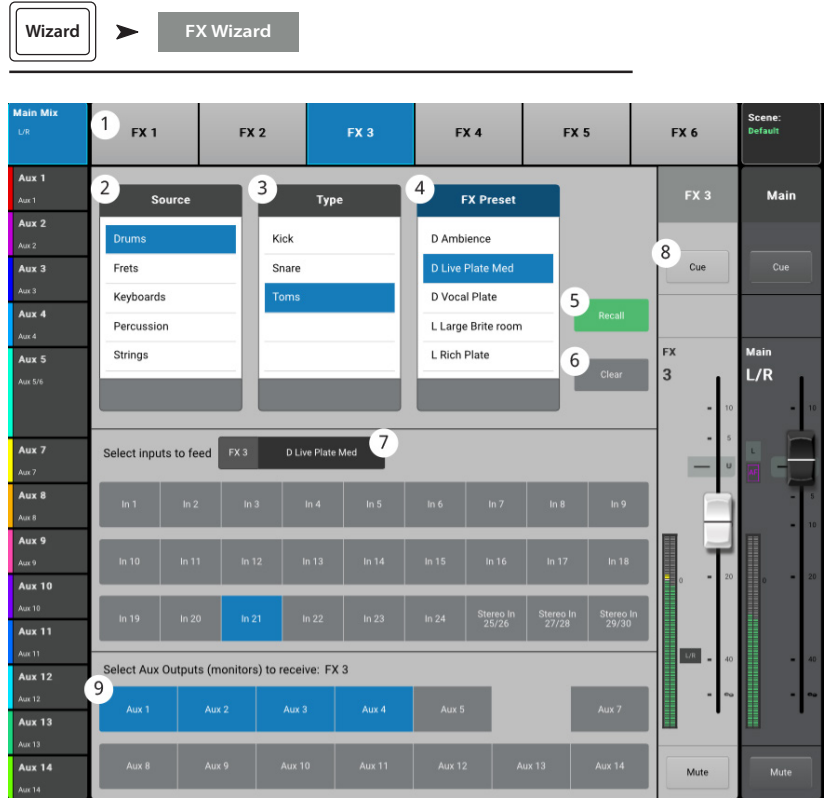

# Gain Wizard

The Gain Wizard monitors input clipping and provides an indication of how much input gain reduction is needed.

Press Wizard  Touch Gain Wizard



**NOTE:** The Gain Wizard provides an indication of the frequency and intensity of clipping to aid in proper adjustment of input sensitivity.

1. **Reset Button** – Use this to clear the Gain Wizard after adjusting the input sensitivity.
2. **Tick-Mark Counters** – Indicates how many tick marks to turn the Trim knob counterclockwise to prevent clipping.
3. **Trim Knob** – Turn this knob (on the TouchMix surface) the number of tick marks indicated on the Tick-Mark counter.



# Room Tuning Wizard

The Room Tuning Wizard assists in adjusting output equalization

1. **Tuning Output** — Displays the system and friendly name of the output being tuned.
2. **Restart** — Go back and start over.
3. **Clear Tuning EQ** — Resets the GEQ, for the currently selected output to the factory default.
4. **Select Output buttons** — Touch the output to be tuned.
5. **Select Measurement Method** — Each method progressively adds more measurement spots to increase the accuracy of the settings. The Skip Measurement, Use Previous method allows measurement data from the last tuning to be used.
6. **Next** — moves the Wizard to the next step. Follow the instructions on the subsequent screens. (see below)

When finished, touch the “Navigate to GEQ” button. The settings display on the output GEQ screen. An outline of the fader knob indicates the tuning wizard settings.

The following illustrations show the procedure.

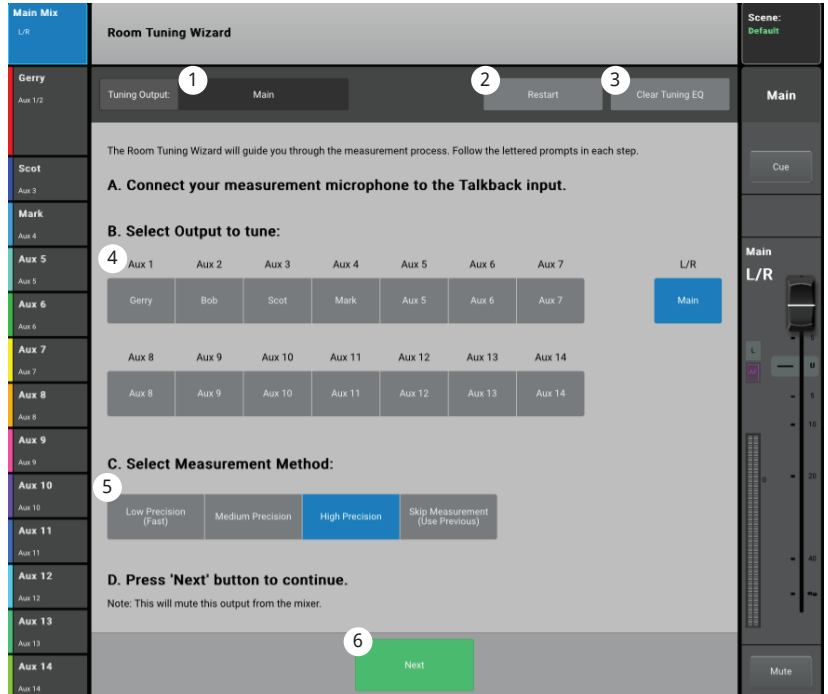
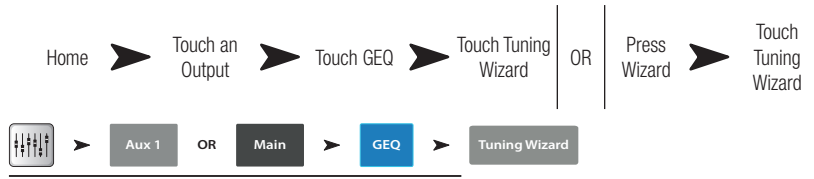

**A. Place Microphone.**  
Place microphone at audience ear height.  
Aimed at a point between the left and right speakers.  
Most Rooms: In the center of the primary listening area.  
Small Rooms: 2/3 of the way back.

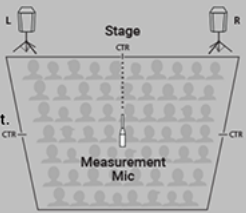

**B. Turn on Phantom Power if Talkback Mic requires it.**

Talkback Mic Phantom Off  48V

**C. Press 'Begin' to measure the ambient room noise.**  
Note: Avoid creating any unnecessary noise while measurement is running.

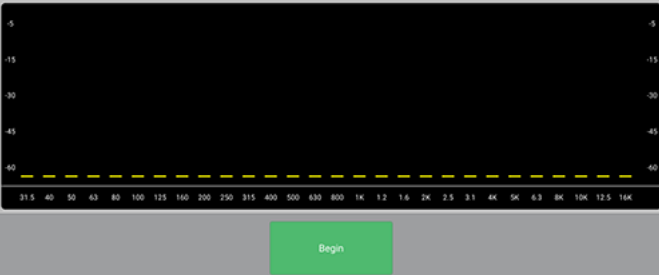

— Step 1 —

**Room Tuning Wizard**

Tuning Output: Main Restart Clear Tuning EQ

**A. Place Microphone.**  
Place microphone near the front of the primary listening area.  
At audience ear height.  
Aimed at a point between the left and right speakers.

**B. Adjust Noise Level.**  
Turn knob to adjust pink noise volume to a moderate level.

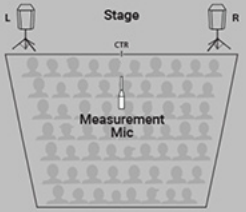

Noise Level  20.0 dB

**C. Take Measurement #1.**  
Press 'Measure' below to measure the frequency response of the room.

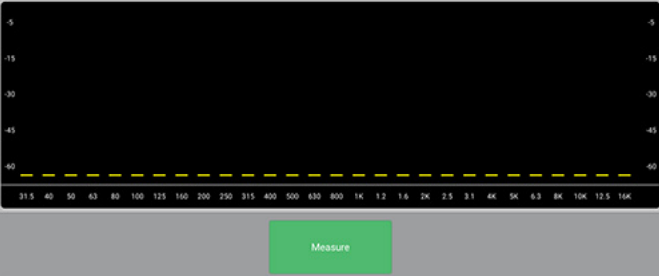

— Step 2 —

**Measurement in progress.**

Avoid creating excess noise.

— Step 3 —

**Room Tuning Wizard**

Tuning Output: Main Restart Clear Tuning EQ

**Measurement Complete.**  
Output is no longer muted. Preview Tuning by selecting a Target EQ curve.

**A. Select Target Tuning to preview:**

**B. Press 'Finish' button below to finalize Room Tuning settings.**

Finish

— Step 4 —

**Room Tuning Wizard**

Tuning Output: Aux 1 Restart Clear Tuning EQ

**Room Tuning wizard completed.**  
Resulting Room Tuning EQ can be viewed on the GEQ Page.

Restart Navigate To GEQ

— Step 5 —

# FX Processor

## FX Processor – Basic Chorus

The Chorus FX Varies the pitch of a signal at a steady rate to “thicken” a sound.

You can access the Effects from the Inputs and Sub Group banks.



1. **Effect** – Touch to select an Effect Type.
2. **Preset** – Name of the current preset. Touch to access the library of Presets.
3. **Simple button** – Turns Simple mode on and off. Hides all but the essential controls on the selected FX. *Not present on Mono and Stereo Delay effects.*
4. **Reset button** – Returns processor and Aux Send controls to their default settings.
5. **Input meter** – Displays the incoming audio level before the Effect.
6. **Output meter** – Display the audio level after the Effect.
7. **LFO Rate knob** – Determines the rate at which the pitch will be varied.
8. **LFO Depth knob** – Controls the amount of modulation applied to the audio signal.
9. **LFO Type switch** – Selects how the pitch will be varied.
10. **Lo Cut knob** – Attenuates, or “cuts” frequencies below this frequency setting. Range is 20 Hz to 2 kHz.
11. **Hi Cut knob** – Attenuates, or “cuts” frequencies above this frequency setting. Range is 200 Hz to 20 kHz.
12. **FX Returns to Monitors**
  - a. **M** – Indicates the Aux Send for the Effect is muted from the Auxes tab.
  - b. **Send Slider** – Sets the level of the Effect to the Aux output, typically the performer’s monitor.
  - c. **Link icon** – Indicates the Auxes are linked.
  - d. **Aux Pan control** – Pans between the two linked Auxes.

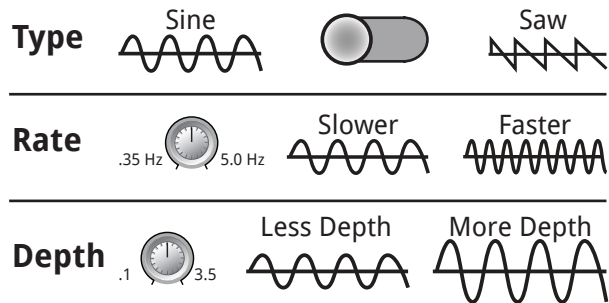



## FX Processor – Dense Reverb

The Dense Reverb (presets with a “D” suffix) is a model of a DSP reverb with more dense reflections that some may find more representative of actual acoustic spaces.

Input channels and Sub Groups are able to send to the effect.



1. **Effect** – Touch to select an Effect Type.
2. **Preset** – Name of the current preset. Touch to access the preset library.
3. **Simple button** – Turns Simple mode on and off. Hides all but the essential controls on the selected effect.
4. **Reset button** – Returns processor and Aux Send controls to their default settings.
5. **Input meter** – Displays the incoming audio level.
6. **Output meter** – Displays the post-effect audio level.
7. **Reverb Time** – Reverb Time (RT) is the length of time required for the reverberation to drop by 60 dB.
8. **Initial Delay knob** – Sets the time interval between input signal and first reflection.
9. **High Ratio knob** – Changes the amount of high frequency reflections.
10. **Diffusion knob** – Controls the density of groups of Early Reflections. Or Simulates the complexity of surfaces off which the sound reflects.
11. **Reverb Delay knob** – Changes the delay between reflections.
12. **Early Reflect knob** – Changes the amplitude of the early reflections.
13. **Lo Cut knob** – Attenuates, or “cuts” frequencies below this frequency setting. Range is to 20 Hz to 2 kHz.
14. **Hi Cut knob** – Attenuates, or “cuts” frequencies above this frequency setting. Range is 200 Hz to 20 kHz.
15. **FX Returns to Monitors** – Sliders adjust the level of the effect heard in the performers’ monitors.
  - a. **M** – Indicates the Aux Send for the Effect is muted from the Auxes tab.
  - b. **Send slider** – Sets the level of the Effect to the Aux output.
  - c. **Link icon** – Indicates the Auxes are linked.
  - d. **Aux Pan control** – Pans between the two linked Auxes.



## FX Processor – Lush Reverb

Reverb presets with an “L” suffix use a DSP reverb model with a more “lush” character.



1. **Effect** – Name of the current Effect. Touch to select an Effect Type.
2. **Preset** – Name of the current preset. Touch to access the library of Presets.
3. **Simple button** – Turns Simple mode on and off. Hides all but the essential controls on the selected FX. **Not present on Mono and Stereo Delay effects.**
4. **Reset button** – Returns processor and Aux Send controls to default settings.
5. **Input meter** – Displays the level of incoming, mono audio signal.
6. **Output meter** – Displays the stereo level of the processed output signal.
7. **Low Cut** – Attenuates, or “cuts” frequencies below the set frequency. Range is 20 Hz to 2 kHz.
8. **Hi Cut** – Attenuates, or “cuts” frequencies above the set frequency. Range is 200 Hz to 20 kHz.
9. **Size** – Adjusts dimension of the simulated acoustic space in meters.
10. **Pre Delay** – Sets the time interval between input signal and first reflection
11. **Low Reverb** – Adjusts the reverb decay time for frequencies below the crossover frequency.
12. **Crossover** – Sets the crossover point for the Low Reverb Time and the High Reverb Time.
13. **High Reverb** – Adjusts the reverb decay time for frequencies above the crossover frequency.
14. **Diffusion** – Adjusts the early reflections to simulate a more or less complex reflective acoustic surface.
15. **FX Returns to Monitors:**
  - a. **M** – Indicates the Aux Send for the Effect is muted from the Auxes tab.
  - b. **Send Slider** – Sets the level of the Effect to the Aux output.
  - c. **Link icon** – Indicates the Auxes are linked.
  - d. **Aux Pan control** – Pans between the two linked Auxes.



# FX Processor – Mono and Stereo Delay

These effects delay the audio signal to create echo and similar effects. Controls for the stereo delay may be linked or operated independently.



Input channels and Sub Groups are able to send to the effect.

1. **Effect** – Touch to select a different Effect Type.
2. **Preset** – Displays the name of the current preset. Touch to access the preset library.
- 3.
4. **Reset** – Returns processor and Aux Send controls to their default settings.
5. **Input** – Displays the incoming audio level before the Effect.
6. **Output** – Displays the post-effect audio level.
7. **Link Button – (Stereo Delay only)** – Links all controls of both channels. Channel two is set to the same level as Channel one.
8. **Delay Knob** – Sets the delay time in milliseconds.
9. **Tap Tempo Button** – Sets the tempo of the regenerations by tapping. Touch the Tap Tempo button, then tap the Master Control knob at a steady rate.
10. **Regen Knob** – Adjusts the amount of delayed signal that is sent back to the input. At 0% only the first echo will be heard. At 99% the echo will repeat indefinitely at the same level.
11. **Lo Cut Knob** – Attenuates, or “cuts” frequencies below this frequency setting. Range is 20 Hz to 2 kHz.
12. **Hi Cut Knob** – Attenuates, or “cuts” frequencies above this frequency setting. Range is 200 Hz to 20 kHz.
13. **FX Returns to Monitors** – Sliders adjust the level of the effect heard in the performers’ monitors.
  - a. **M** – Indicates the Aux Send for the Effect is muted from the Auxes tab.
  - b. **Send Slider** – Sets the level of the Effect to the Aux output.
  - c. **Link icon** – Indicates the Auxes are linked.
  - d. **Aux Pan control** – Pans between the two linked Auxes.



## FX Processor – Pitch Shift

The Pitch Shift raises or lowers the pitch of an audio signal by a fixed interval. In addition, the signal can be delayed from the original. The two output channels can be adjusted independently.



1. **Effect** – Touch to select an Effect Type.
2. **Preset** – Name of the current preset. Touch to access the library of Presets.
3. **Simple button** – Turns Simple mode on and off. Hides all but the essential controls on the selected FX. *Not present on Mono and Stereo Delay effects.*
4. **Reset button** – Returns processor and Aux Send controls to their default settings.
5. **Input meter** – Displays the incoming audio level before the Effect.
6. **Output meter** – Display the audio level after the Effect.
7. **Left and Right Shift knobs** – Set the amount of shift, down (-) or up (+) for the two output channels.
  - 100¢ = 1 half step,
  - 200 ¢ = 1 whole step,
  - 1200¢ = 1 octave
8. **Lo Cut knob** – Attenuates, or “cuts” audio below the set frequency. Range is 20 Hz to 2 kHz.
9. **Hi Cut knob** – Attenuates, or “cuts” audio above the set frequency. Range is 200 Hz to 20 kHz.
10. Rotating the Master Encoder will change the amount of pitch shift in half-step intervals. For finer adjustments, hold the Encoder down while adjusting.
11. **Left and Right Delay knobs** – Adds up to 100 milliseconds of delay to the Pitch Shift output.
12. **FX Returns to Monitors:**
  - a. **M** – Indicates the Aux Send for the Effect is muted from the Auxes tab.
  - b. Send slider – Sets the level of the Effect to the Aux output, typically the performer's monitor.
  - c. Link icon – Indicates the Auxes are linked.
  - d. Aux Pan control – Pans between the two linked Auxes.



# FX Processor – Pitch Correct

Corrects intonation of the audio signal.



**IMPORTANT!:** Pitch-Correct may be enabled/disabled by User Buttons without regards to the position of the Enable button on this screen. If you don't hear any difference with Pitch Correct enabled, check to make sure the feature has not been disabled using the User Button feature. Refer to the User Button topic.

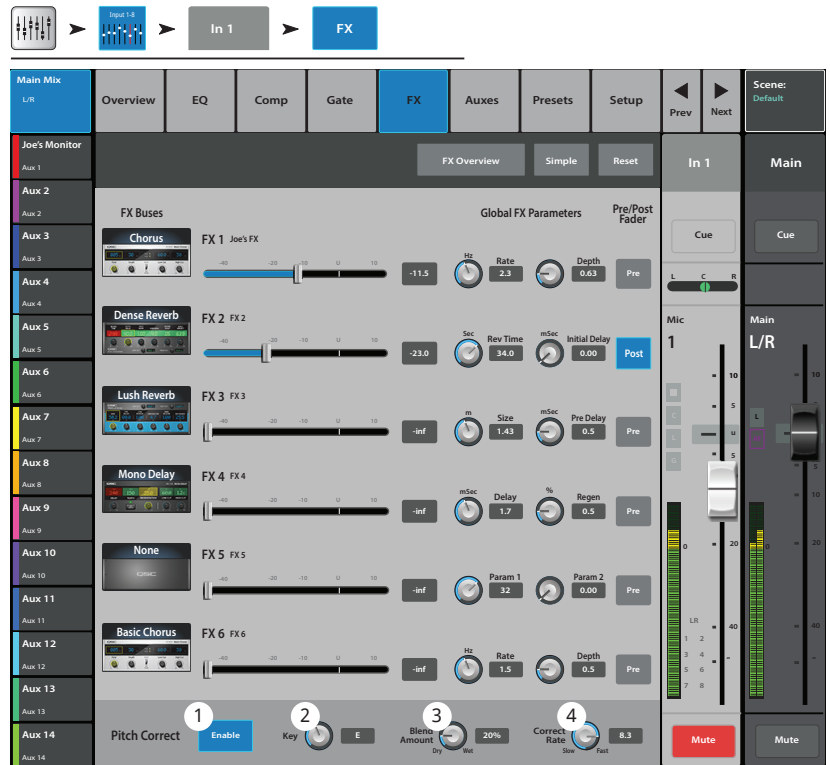

- Pitch Correct Enable button** – Assigns Pitch Correct to the currently selected channel and enables/disables the effect.
- Key knob** – Selects a key for the pitch corrector to use in determining the target note. If “None” is selected, the Pitch Corrector will target the nearest chromatic pitch. The table shows the Key selections.
- Blend knob** – Sets the ratio of uncorrected (Dry) to corrected (Wet) signal. When fully clockwise, only corrected signal will be heard. When fully counter clockwise, only the original signal will be heard. Intermediate settings will result in a doubling effect.
- Correct Rate knob** – determines how quickly the pitch is corrected.

### Key Selection

None	E	A
C	F	A sharp / B flat
C sharp / D flat	F sharp / G flat	B
D	G	
D sharp / E flat	G sharp / A flat	

## REMOTE CONNECTIONS



**NOTE:** For remote devices only. Lists any TouchMix mixers found on the network to which your device is connected.

When multiple TouchMix mixers are connected to a single network, this page is used to select a single mixer to control with a tablet device.

1. List of mixers connected to the same network as your device. In the example there are three mixers.
2. The blue highlight indicates which mixer is selected. Touch the name of a mixer to change the selection.
3. **Select button** – Touch this button to connect your device to the selected network.
4. **Cancel button** – Touch this button to close the dialog without making any changes.
5. Example “5” shows a mixer (My TM-30) that created a network, and the remote device that is viewing the “Remote Connections” page, is connected to the created network.

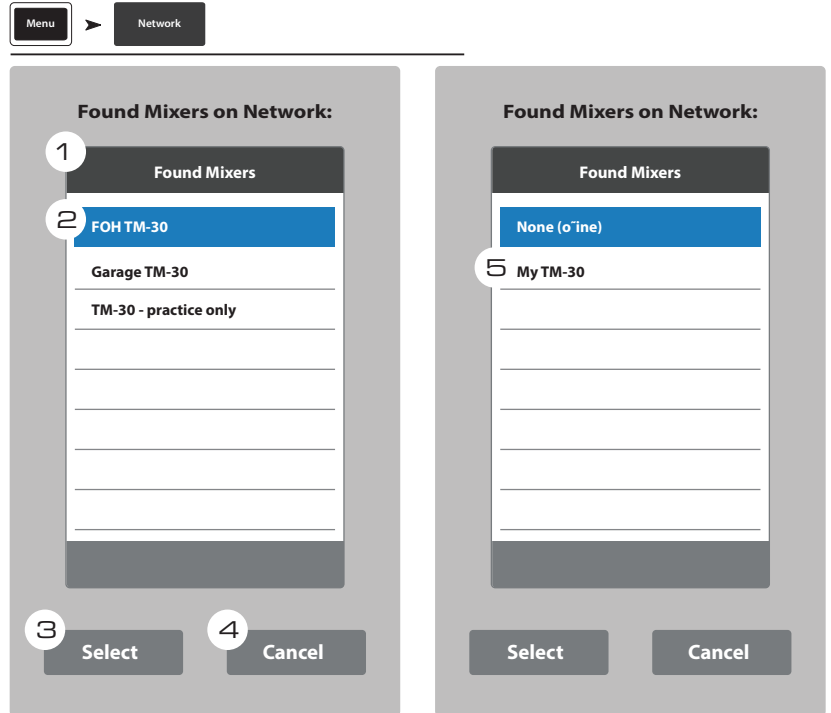

# Security

Provides four levels of password-enabled security to TouchMix functionality.

Press Menu ➔ Touch Security

## Login Screen

1. **Current Login** – The level of the person currently logged in.
2. **Security Settings button** – Touch to access the Security Settings where passwords can be set for all levels.
3. **Logout / Lock button** – Touch to logout of the Security Settings.
4. **Enter Password** – Touch the white area to enter a password. If passwords are not set, go directly to the Security Settings.

## Security Setup



**IMPORTANT!** Setting the password for Administrator enables the Security feature. Leave this field empty to operate the mixer without security restrictions. However, if the mixer is accessible to others, it may be a good idea to enter an administrator password to prevent mischievous or inadvertent password creation that would lock you out of your own mixer.



**NOTE:** Forgotten Administrator Password? Contact QSC Technical Support.

1. **Current Login** – The level of the person currently logged in.
2. **Close Security Settings button** – Touch to return to the Security Setup page where can login again, or press Home to exit.
3. **Logout / Lock button** – Touch to logout of the Security Settings, displays the Login button.
4. **Set Passwords** – Enter a password in one of the text boxes to protect the corresponding functions. Leave the field blank if you want to give anyone access to that level of functionality.
5. **Administrator** – Setting a Password enables security. Logging in as Administrator gives access to all mixer functions including Security Settings. Be certain to remember this password!
6. **All Access** – Allows access to all mixer functions except Security Setup.
7. **Simple Mode Only** – Allows access to all simple-mode mixer functions for screens having a Simple / Advance choice, and all other functions except Security Setup.
8. **Levels Only** – Access to level controls only.
9. **Overwrite Scenes & Presets** – Allows or denies the ability to change a Scene or Preset in user memory.
10. **Recall Scenes** – Allows or denies the ability to recall a scene from memory.
11. **Recall Presets** – Allows or denies the ability to recall a preset from memory.
12. **Auto Lock On/Off** – Automatically logs out the current password after a preset period.
13. **Hours and Minutes** – Sets the amount of time it takes for the Auto Lock to be activated.

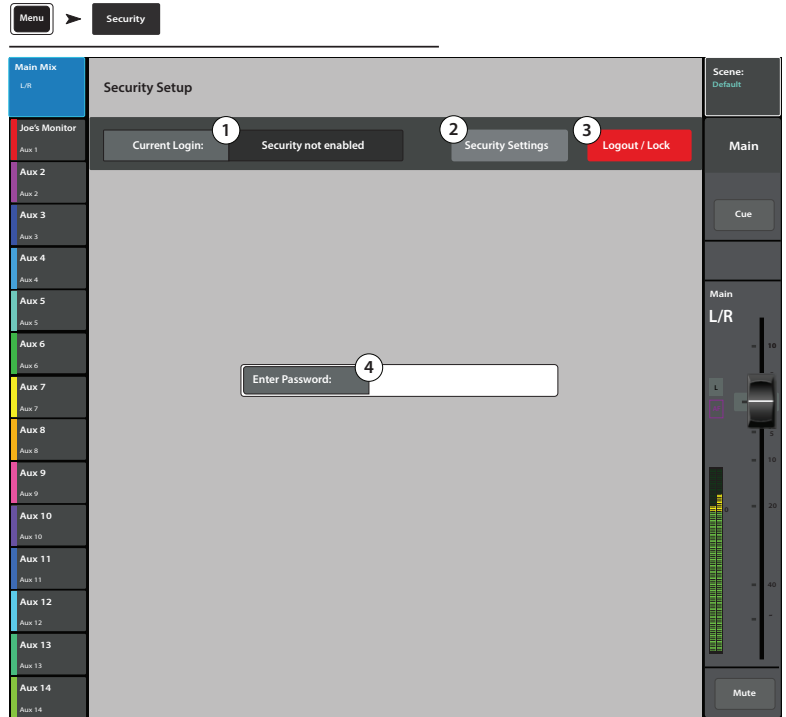

Press Menu ➔ Touch Security ➔ Touch Security Settings





# Miscellaneous Features

## Menu

The Menu provides links to various utility, setup and control functions.

1. **Scenes, Snapshots, Cue Lists** – ([Scenes, Snapshots and Cue Lists on page 123](#))
2. **DCA Groups** - ([DCA Group Assignments on page 108](#))
3. **Talkback (Noise)** - ([Talkback / Noise on page 110](#))
4. **Patch Matrix** - ([Patch Matrix \(TouchMix-30 Pro only\) on page 120](#))
5. **FX Overview** - ([FX Overview on page 80](#))
6. **Backups** - Opens a screen (similar to Scenes) that may be used to create or recall a complete, archival backup of all the mixer's Scenes, Snapshots and Cue Lists and user presets. The backup may be saved to Mixer Internal memory, an external USB drive or to the tablet that's controlling the mixer.
7. **Auto Mixer** - ([Auto Mixer TouchMix-30 Pro on page 105](#)).
8. **External Faders** - Intended for applications where an external fader controller is used. Removes the on-screen faders from the channels and substitutes a more detailed channel display. Please go to [www.qsc.com](http://www.qsc.com) for more detail on selecting and using external, MIDI fader controllers.
9. **Clear Clip** - Resets clip indications on the Nav Strip. The clip indications are cleared only on the device on which the clear Clip button was pressed. By default, User Button 2 also performs this function
10. **Clear Mute** - Unmutes all Mutes except Mute Groups and DCA Mutes.
11. **Clear Cue** - Clears the Cue. By default, User Button 3 also performs this function.
12. **Clear Copy / Paste** - Deletes previously copied items from the mixer's temporary memory.
13. **Mixer Setup** - ([Mixer Setup on page 96](#))
14. **User Buttons** - ([User Buttons on page 95](#))
15. **Custom Banks** - Opens a screen where input and output channels may be rearranged. The Custom Banks control (upper left, Home screen) switches between the factory and custom banks arrangements.
16. **MIDI (Mixer only)** - Opens a screen where the mixer can be set to respond to MIDI (over USB) commands.
17. **Network (Mixer only)** - ([TouchMix Wi-Fi Control on page 111](#))
18. **Select Mixer / Offline (App only)** - Opens a selection menu that displays a list of TouchMix-30 Pro mixers discovered on the network. The user may select a mixer to control or select Offline Mode. In Offline Mode, the user can create, edit and store Scenes, Snapshots and Cue Lists without connection to a mixer. When the tablet is connected to a mixer, the Scenes, Snapshots and Cue Lists may be copied to the mixer's memory and recalled. To exit Offline Mode, simply close and restart the app.
19. **Remote Control (Mixer only)** - ([Remote Control Settings on page 94](#))
20. **Security** - ([Security on page 92](#))
21. **Channel Safe** - ([Channel Safe on page 104](#))
22. **Simple** - Presents a simplified set of controls with more advanced functions omitted. Switching between Simple and Advanced mode will not alter any existing mixer control settings.
23. **Advanced** - Returns the mixer controls to the default state with all functions available.
24. **Language** - Changes the language for Info and Demo screens.

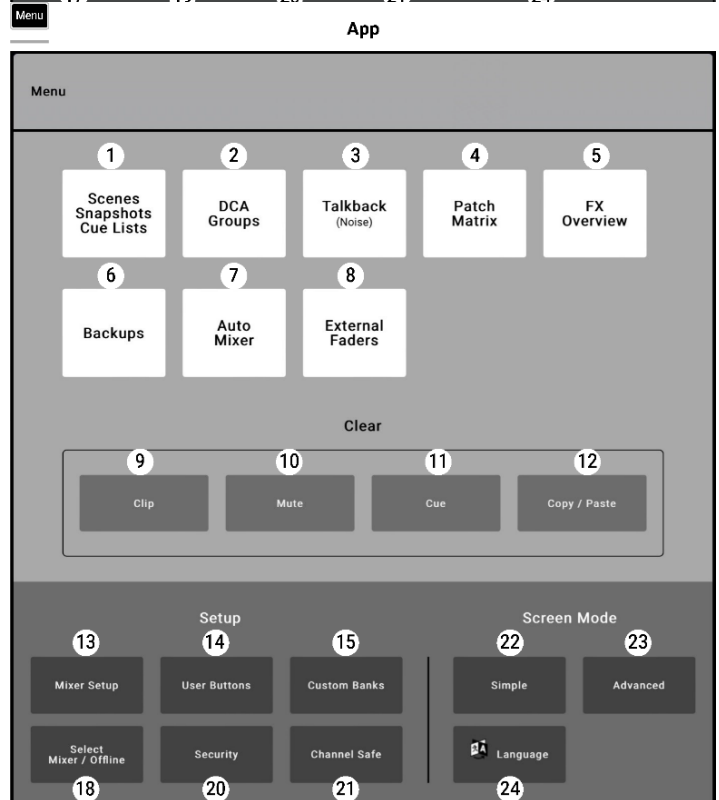
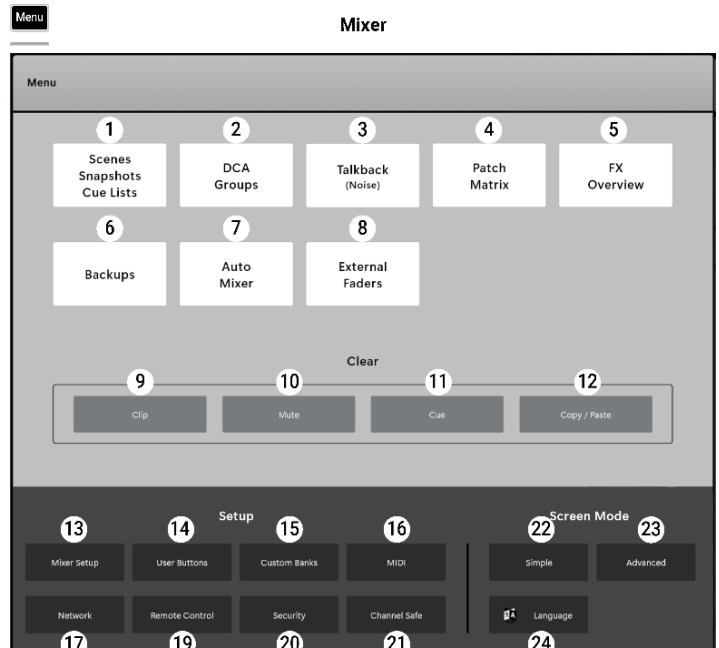



# REMOTE CONTROL SETTINGS

Allows or restricts access to mixer functionality by device.

Press Menu  Touch Remote Control



**NOTE:** When a remote device is set to Personal Monitor Mix, the Cue and Mute buttons are not available on the Aux-Mix-on-Faders.



**NOTE:** Some Android™ devices use the model number as the device name. This may cause contentions if there is more than one of the same model device (name) connected to TouchMix. To avoid this situation, turn on Bluetooth on the Android device, and change the device's name to something unique. Bluetooth must remain on to prevent reverting to the model number.

When a new device connects to the mixer's network and the TouchMix Control App is launched, the mixer displays a message indicating that a new device is connected.

1. **Devices** — Displays a list of devices that are or have been connected to the mixer. Touch a device name to set up its access.
2. **Personal Monitor Mix** — Enables access to a combination of these functions.
  - a. **Main Mix** — Control of the Main mix functions.
  - b. **Record** — Control of the recording transport and setup function.
  - c. **User Buttons** — Access to the User Buttons.
  - d. **Auxiliary Channels** — Access to one or more aux channel (stage monitor) mixes.
3. **Full Access** — The device has access to all software controlled mixer functions.
  - **Security Settings** — (not shown) If enabled, a password is required. See the Security topic.
4. **Remove Device** — Removes the selected device from the list.
5. **Save** — Saves the settings and sends a message to the device listing available functions.

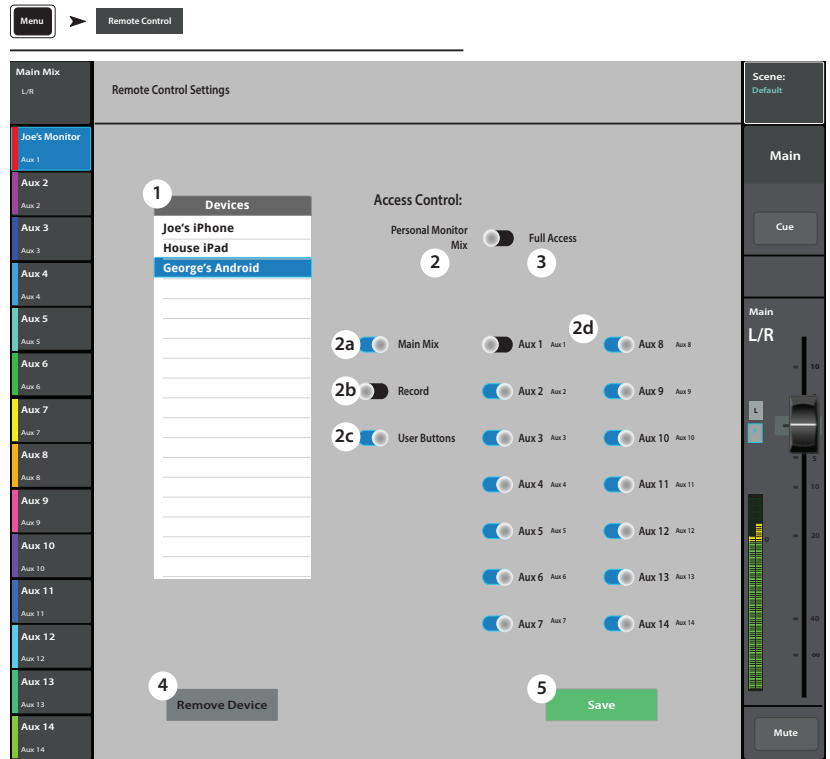

# User Buttons

Assign alternate functions to the User Buttons.

Press Menu  Touch User Buttons

- User 1** through **User 8** – Displays the current **Detail** (function) assigned to the selected User 1–8 button. Touch a button to edit its function.
- User Button Name** – Displays the **Detail** name associated with the selected **User 1–8** button. Changing the function assigned to the button will automatically enter a new name, or touch the keyboard icon to enter a custom name.
- a. **Action**, b. **Selection**, c. **Detail** – Select an item from each list in the order shown.
- Assign** – Touch to complete the assignment.
- Reset** – Resets the selected **User 1–8** button to default setting.

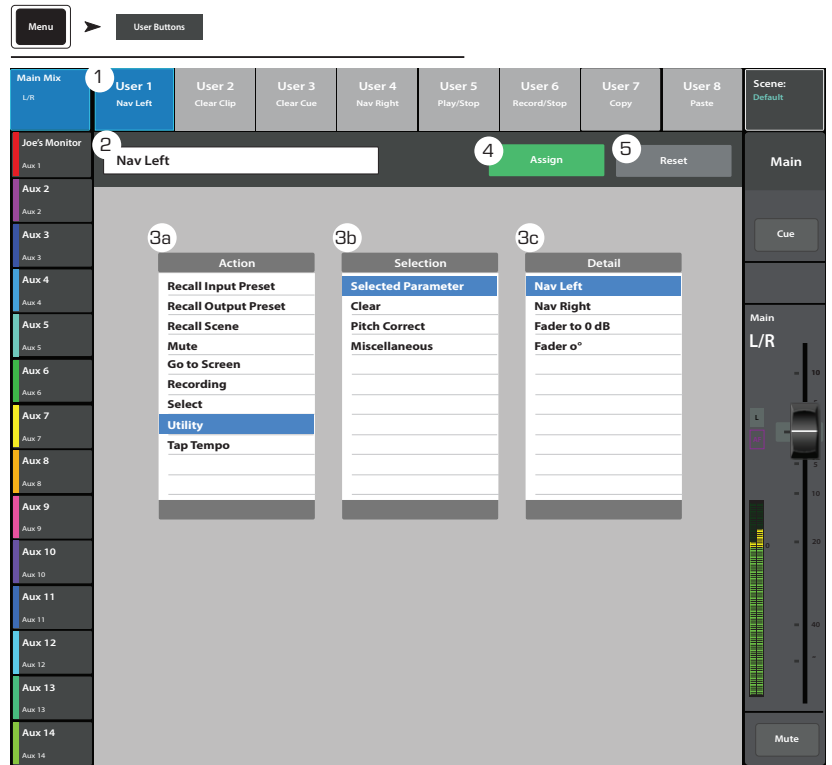

**Alternate Method** of setting a User button to navigate to a specific screen. Does not apply to remote devices.

- Navigate to the desired screen.
- Press and hold a user button for 2 – 3 seconds.
- Upon release, a message displays. Touch **Yes** to accept the change or **Cancel** to reject it.
- If desired, assign the user button a friendly name from the User Button Setup screen.

To return the user button to the factory default, press it one time to access the assigned page. Then push and hold the user button for 2-3 seconds.









**NOTE: PITCH CORRECT** – This function disables or enables the Pitch Correct feature, it does not affect the assignment of the feature to a channel. The only way to tell if this feature is enabled or disabled at the User Button level is to see if you can hear a difference when Pitch Correct is assigned to a channel. If you select Utility > Pitch Correct >, you need two user buttons, one to enable the feature, the other to disable it. Refer to the Pitch Correction topic for information about assigning or enabling Pitch Correct for a channel.

## User button defaults:

### TouchMix-30 Pro

-  – Navigate Left (moves the selection left)
-  – Clear Clip (clears clipping indication from the Nav Strip)
-  – Clear Cue (clears all cue selections)
-  – Navigate Right (moves the selection right)
-  – Play/Stop (starts or stops playback)
-  – Rec/Stop (starts or stops recording)
-  – Copy (see Copy & Paste)
-  – Paste (see Copy & Paste)

### TouchMix-8 / TouchMix-16

-  – Navigate Left (moves the selection left)
-  – Copy (see Copy & Paste)
-  – Paste (see Copy & Paste)
-  – Navigate Right (moves the selection right)
-  – Play/Stop (Tablet app only)
-  – Rec/Stop (Tablet app only)
-  – Clear Clip (Tablet app only)
-  – Clear Cue (Tablet app only)

# Mixer Setup

Controls for various global and utility functions.

Press Menu  Touch Mixer Setup

1. **Cue Mode** — Sets the function of the channel Cue buttons.

- Cue (Default)— Touching a channel cue button causes the channel’s signal to be heard in the Cue headphones. The audio signal is otherwise unaffected.
- SIP (Solo In Place) – Input Cue buttons change color (orange) and are labelled SIP. Touching a channel’s SIP button causes all other inputs to mute. Cue continues to function normally for outputs. SIP is a very useful setup function but can produce unwanted results if left on during performance.

2. **Cue Pickoff** — Determines if the Cue signal is derived pre or post-fader.

- **PFL** (Pre-Fader Listen)
- **AFL** (After-Fader Listen)

3. **Sample Rate** — Selects the sample frequency (bit rate) for the mixer. Most relevant for recording. Typically, 44100 is used for audio CD, and 48000 for audio with video.

4. **Dynamics Processing (global)** — Determines whether all input channel gates and compressors are controlled by a pre or post EQ signal.

5. **Demo Mode and Confirm Mute**

- **Demo Mode (Mixer only)** — The mixer is set at the factory to display a slide show of features until the screen is touched. This control turns the demo on/off.
- **Confirm Mute on Master (tablets only)** — By default, muting a master output (Main or Aux bus) requires a confirmation. This switch eliminates the confirmation step.

6. **Omit Levels on Paste Overview** — Provides an option to omit all level settings when pasting to an overview screen.

7. **Display Brightness** — Controls the brightness of the LCD screen and illuminated buttons.

8. **Save System Log to USB** — Writes a file to USB that may be useful in software troubleshooting.

9. **Clear Storage** — Deletes all user-defined presets and scenes from the mixer. Does not delete presets or scenes stored on a USB device.

10. **Reset Mixer** — Resets all mixer controls to factory default. This does not erase any user presets on the mixer or on a USB drive.

11. **Software Version Label** — Displays the version number of the currently installed firmware.

12. **Start Upgrade (Must Download First)** — Begins the process of upgrading mixer software. Before starting, either visit [www.qsc.com](http://www.qsc.com) for upgrade instructions and to download the latest firmware version, or go to the following step.

13. **Check and Download Upgrade** — This function is available on TouchMix-30 Pro with version 1.1 or higher and TouchMix-8 and TouchMix-16 with version 3.0 or higher. You must have an Internet connection and a USB drive (with about 250 MB free) to download the upgrade files. When you use this method, follow the instructions on the screen. The mixer checks for the latest version, and downloads it automatically. If you have the latest version, you will get a message indicating that.



**NOTE:** For the TouchMix-30 Pro the Internet connection can be wired, or wireless via a compatible wireless adapter (Part # CP-000033-00 is available from QSC) connecting to a wireless router with Internet access.

For the TouchMix-8 and TouchMix-16 you must connect via the wireless adapter to a wireless router with Internet access. or to a router using a USB to Ethernet adapter.

14. **End User Agreement** — Displays the End User License Agreement for your reading pleasure.

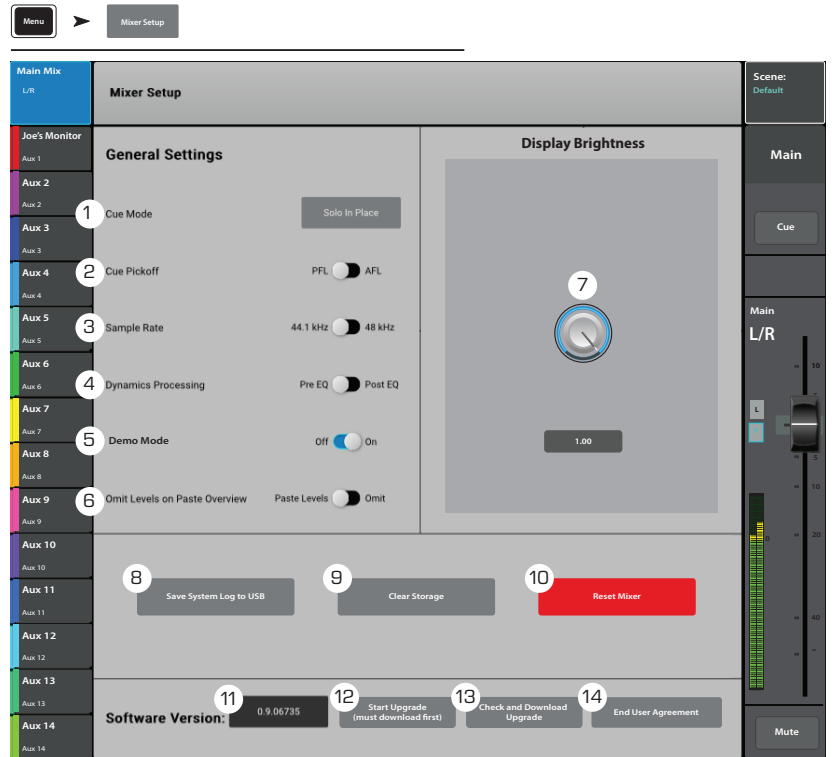

# Phantom Power

Supplies +48 VDC to XLR Inputs including Talkback.

Press  
Mic 48V

1. **Reset** — Returns all settings to factory default (all phantom power off).
2. **Input Channel buttons** — Touch to enable or disable phantom power for the channel.
3. **Rear Panel View XLRs** — Touch to enable or disable phantom power for the channel.



**NOTE:** Phantom power may also be controlled from the Setup screen of each input channel.



**NOTE:** It is good practice to turn off phantom power when connecting or disconnecting an input. “Hot patching” a device can cause severe transients and potentially damaging current surges.

The screenshot displays the 'Phantom Mic Power' control interface. At the top left, there is a 'Mic 48V' button. The main control area is titled 'Phantom Mic Power' and includes a 'Reset' button (labeled 1) and a grid of input channels (In 1 to In 24) with a 'Talkback' button and a '+48 V' indicator (labeled 2). Below this is a 'Rear Panel View' section (labeled 3) showing a grid of XLR connectors with '+48 V' indicators. The interface includes a 'Main Mix' sidebar on the left and a 'Scene: Default' sidebar on the right.

# Mute Groups

Mute Groups provide a means of muting multiple inputs and outputs from a single control.

Press Mute Groups

## About Mute Groups

When a channel is in one or more Mute Groups, all Mute Groups containing the same channel and the Channel Mute itself, must be unmuted for audio to pass. When a channel is muted by a mute group, its mute button will be colored orange.

## Mute Groups Screen

1. **Edit** — Touch the Edit button to add or remove channels from Mute Groups.
2. **Mute Group** — Touch any button to activate or deactivate the Mute Group.

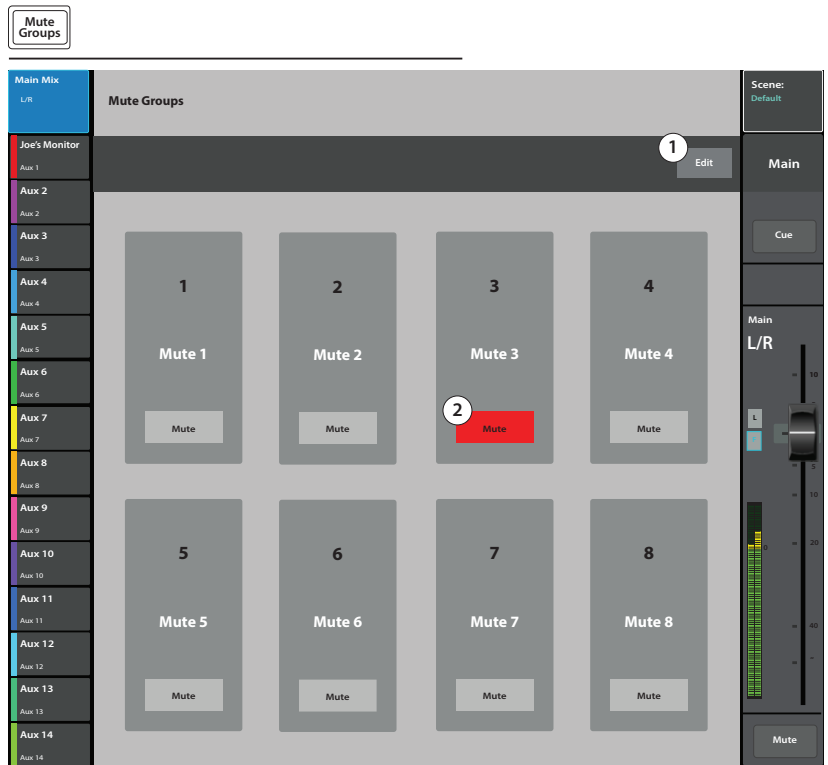

## Mute Group Edit Screen

1. Mute Group select — Selects a Mute Group for editing.
2. User-defined name — Touch the name to display a keyboard that may be used to enter a name for the Mute Group.
3. **Mute** — Mutes / unmutes the channels assigned to the Mute Group being edited.
4. **Clear Assignments** — Clears all assignments from the selected Mute Group.
5. **Close Edit** — Returns to the Mute Group Mute screen.
6. System-assigned channel numbers.
7. **Assignment** — Assigns / unassigns a channel to the selected mute group and indicates assignment status.
8. When a channel is muted by a Mute Group, the color of the channel's Mute button is orange. When a channel is muted by the channel Mute button and a Mute Group, the channel's Mute button is red. All mutes associated with a channel must be unmuted for audio to pass.

Press Mute Groups → Touch Edit

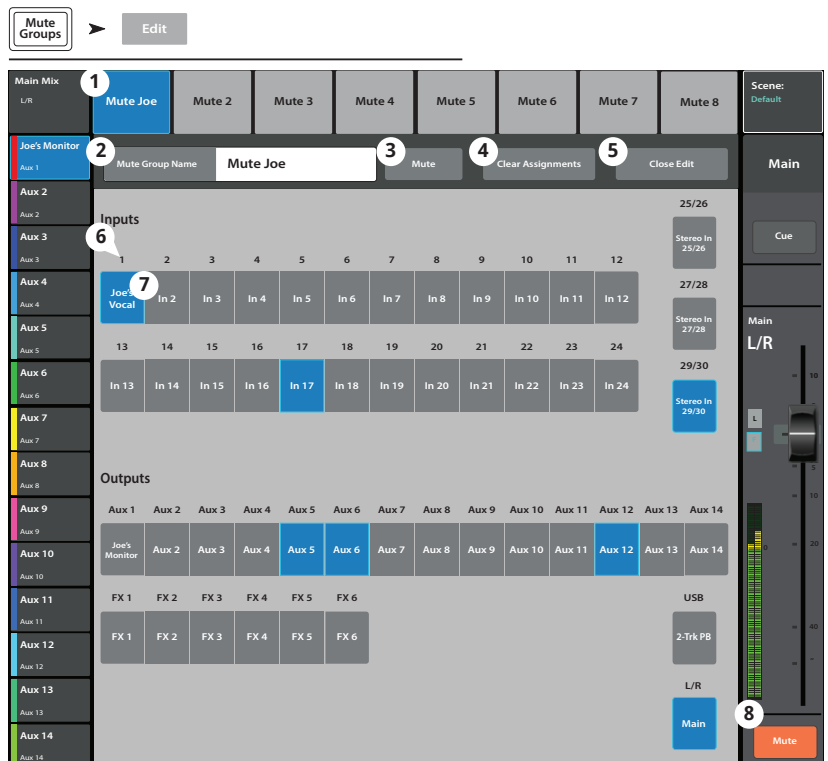

**NOTE:** Mute Groups may be assigned to User Buttons. See the User Button topic for more.

## Record / Playback (Multitrack USB Drive)

Provides the controls to record and playback multiple channels.

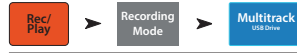

### Record / Playback – Main Screen



**IMPORTANT!:** All USB memory devices must be formatted as FAT32. Drive performance is critical for recording. For more information and to see a list of qualified drives, visit [qsc.com](http://qsc.com).



**NOTE:** At the end of a session, the recording must be stopped using the Stop/Pause control. Stopping the recording writes a header file that is required for the tracks to play.



**NOTE:** All the standard channel controls act as they do regardless of record / playback status. For example, if you Mute the channel that is recording, the output gets muted, but recording of the input continues.

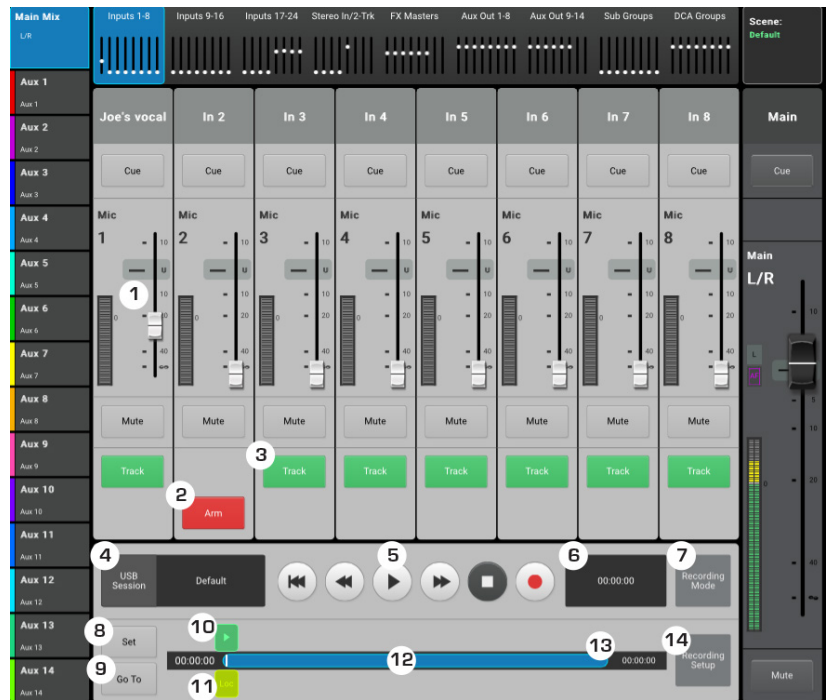

1. **Input Channel controls** – All input channel controls function as they do from the Home screen.
  2. **Arm** – Arms the channel to be recorded when the Record button is pressed. Displays here and on the Home screen .
  3. **Track** – When engaged, selects a recorded track as the audio source for the channel instead of the analog input.
  4. **USB Session** – Displays the name of the active multi-track recording session.
  5. **Transport controls** – Standard transport controls; Return to Start, Rewind, Play, Forward, Pause and Record.
  6. **Total record time counter** – The total length of the recording in HH:MM:SS. If recording is in progress, this number grows until the recording is ended.
  7. **Recording Mode** – Displays a panel for selection of Stereo MP3, Multitrack or DAW (see the MP3 Audio Player and DAW topics).
  8. **Set** – Moves the Locate pointer to the position of the Play pointer.
  9. **Go To** – Moves the Play pointer to the position of the Locate pointer.
  10. **Play pointer** – Indicates current record/playback position.
  11. **Locate pointer** – Marks a location on the Time Line. The locate pointer may be moved by dragging on screen, by selecting and turning the Master Encoder or using the Set button.
  12. **Progress indicator** – Represents the session time line.
- NOTE:** Due to FAT32 file size limitations, the max continuous recording time is roughly three hours. A warning message is displayed 10 minutes before the limit is reached. To continue recording, pause and then resume. It is not necessary to create a new session. (see “Recording Directory Structure” for more).
13. **Time code display** – Displays position of the Play pointer in HH:MM:SS. Maximum record time is determined by the capacity of the attached hard-disc drive.
  14. **Recording Setup** – Navigates to the Recording Setup screen.

## 2-Trk – Recording

The Main L/R or Aux 13/14 can be recorded on a USB device, then played back using 2-Trk Playback.

Touch Home ➔ Touch Stereo In/2-Trk ➔ Touch 2-Trk Rec

### 2-Trk Recording Setup

The files created from recording are on the external USB device installed in the mixer USB port. The files can be found under <session name>.tmRecord\Track31\Region-1.wav and \Track32\Region-1.wav.

You can stop recording, then resume and two more files are created: \Track31\Region-2 and Track32\Region-2. The files in each directory are concatenated for seamless playback using 2-Trk Playback.

For TouchMix-8 – Tracks 13 and 14

TouchMix-16 – Tracks 21 and 22

1. **Channel Name** – Touch the record field to change the channel name.
2. **Record Source Select buttons** – Select the source for 2-Trk recording. Main L/R or Aux 13/14.
3. **Record Pick-Off switch** – Determines if the recorded audio is:
  - **Post** – affected by the channel EQ and Dynamics, or
  - **Pre** – is not affected by the channel EQ and Dynamics.
4. **Recording Arm button** – When engaged, the source channels you selected are recorded when recording begins. This button is also available on the Record/Play screen.
5. **Export 2-Trk** – (TouchMix-30 Pro only) Converts 2-track wave recording to MP3. Note that this operation is processor intensive and will take some time.

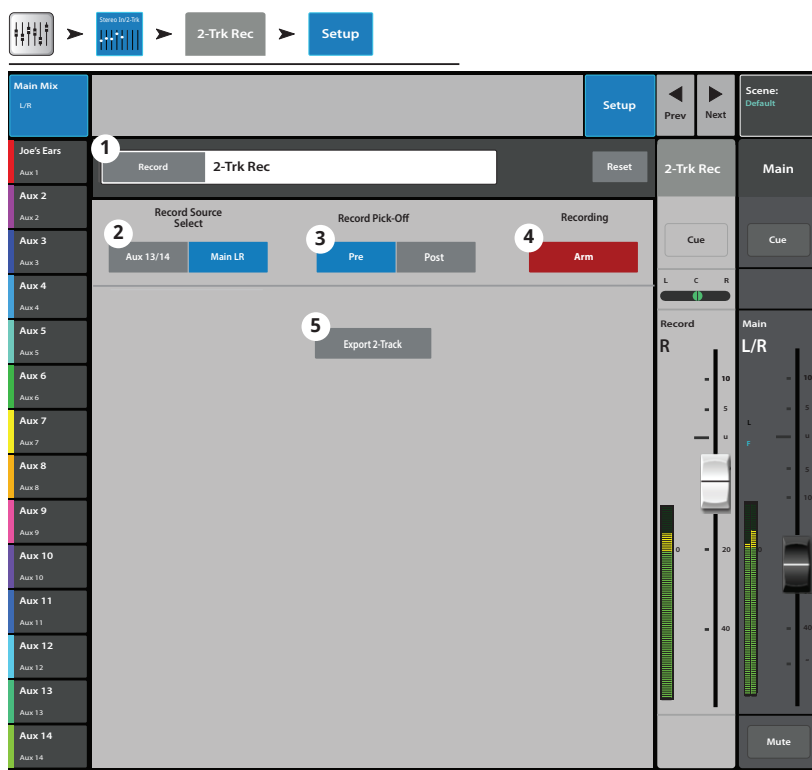



# DAW – Record / Playback (TouchMix -30 Pro only)

Record to and Playback from a Digital Audio Workstation.



**IMPORTANT!** The TouchMix-30 Pro is capable of 32 x 32 channel USB audio interface to Windows and macOS computers. Windows interface requires a driver available for download from QSC. No driver is required for macOS operation.

1. **Track button** – Touch the Track button to select a DAW track as the source for the channel.
2. **DAW** – Indicates if the mixer is receiving audio from the DAW (Connected) or not (Not Receiving Audio).
3. **Sample Rate switch** – Switches the mixers sample rate between 44.1 kHz and 48 kHz. The mixer must be the sample rate clock master.
4. **Recording Mode button** – Touch this to change the Recording Mode to MP3 Playback or Multitrack USB.
5. **Channel Activity** – Lights to indicate audio is being received from the DAW on that channel.



**NOTE:** To manage connections on the Mac – Open “Audio MIDI Setup” and select “QSC TM30 Pro.”



# Real-time Analyzer (RTA)

Displays a real-time analyzer (RTA) for the selected source.

- TouchMix-30 Pro – Up to two RTA displays are available at a time on any combination of mixer and tablet devices.
- TouchMix-8 and TouchMix-16 have one RTA.
- The RTA is not available on phone devices.

1. The system and friendly name for the RTA Source.
2. RTA Graph – 28, 1/3 octave bands, with peak-hold indicators available for the tablet devices only.
3. RTA Source – Selectable outputs for the RTA Source – 14 Aux outputs, Main L/R, Talkback, and Follow Cue.  
When set to Follow Cue, the RTA displays the audio present on the Cue mix. Whatever is being heard on the Cue headphones will be displayed on the RTA.
4. Source Master channel – When you select an output source from the main RTA screen, the master controls for the output bus are available.

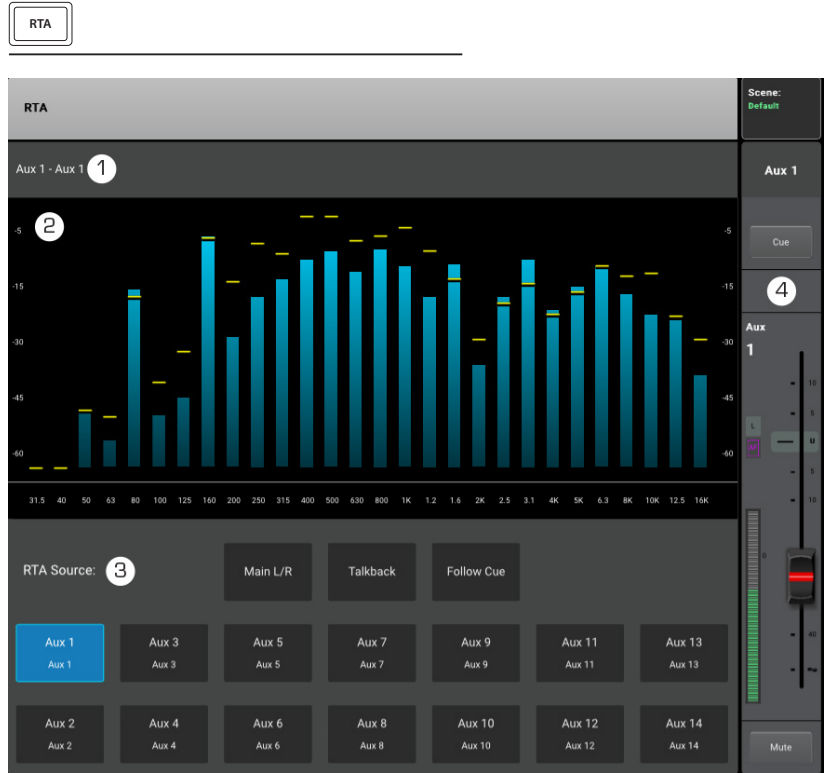

# Scenes

Scenes provide the ability to store and recall all mix parameters.

Touch Scenes OR Touch Menu ► Touch Scenes

1. **Current Scene** — Displays the name of the most recently recalled scene.
2. **Save / Save As button** — Displays a page with options for naming a scene and selecting internal or USB storage.
3. **Factory scenes list** — A library of preset scenes representing mixer settings for a variety of bands, productions and styles. Factory memory is read-only.
4. **Mixer scenes list** — Displays a list of scenes that have been saved to the mixer’s internal memory.
5. **USB list** — Displays a list of scenes that have been saved to an attached USB memory device.
6. **Copy to USB** — Copies the selected scene from Internal memory to an attached USB memory device.
7. **Copy to Mixer** — Copies the selected scene from an attached USB memory device to Internal memory.
8. **Delete** — Deletes the selected Internal or External scene.
9. **Recall** — Recalls the selected Scene.
10. **Recall Options** — Scenes are saved with all parameters but it isn’t always desirable to recall all parameters. This section can be set so that some mixer settings are not effected by a scene recall.
  - a. **Omit Levels** — Mix levels including Aux sends, FX sends and Output levels are unaffected.
  - b. **Omit Outputs** — Output EQ, Anti-Feedback, Comp/Limiter are unaffected.
  - c. **Omit Routing** — Sub Group and Main L/R assignments are unaffected.

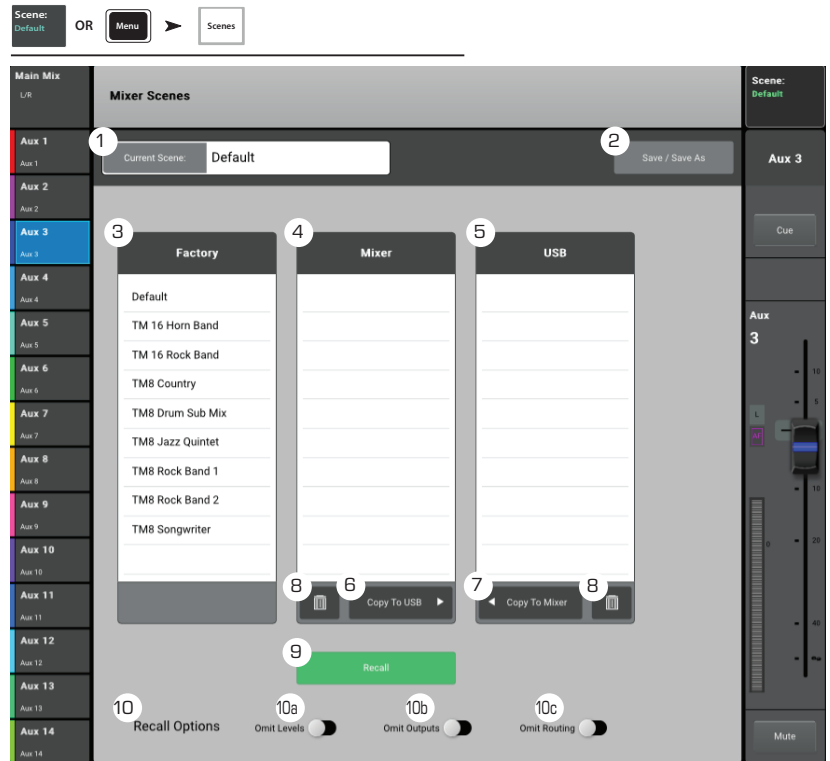

**IMPORTANT!** It is possible to recall TouchMix-8 and TouchMix-16 scenes on a TouchMix-30 Pro. Of course the TouchMix-30 Pro has far more inputs and outputs. These excess inputs and outputs will be set to factory default values.

# Channel Safe

Channel Safe prevents channel settings from being changed when a Scene is recalled. You can set the Channel Safe property for inputs on an Input Channel's Setup screen, and for outputs on an Output Channel's Setup screen. The Channel Safe screen provides the capability of setting multiple channels to safe in one place.

1. **Clear Safe Channels** — Touch this button to remove the Channel Safe from all channels.
2. **Inputs** — Touch each Input channel you wish to keep safe.
3. **Outputs** — Touch each Output channel you wish to keep safe.

Press Menu ➤ Touch Channel Safe

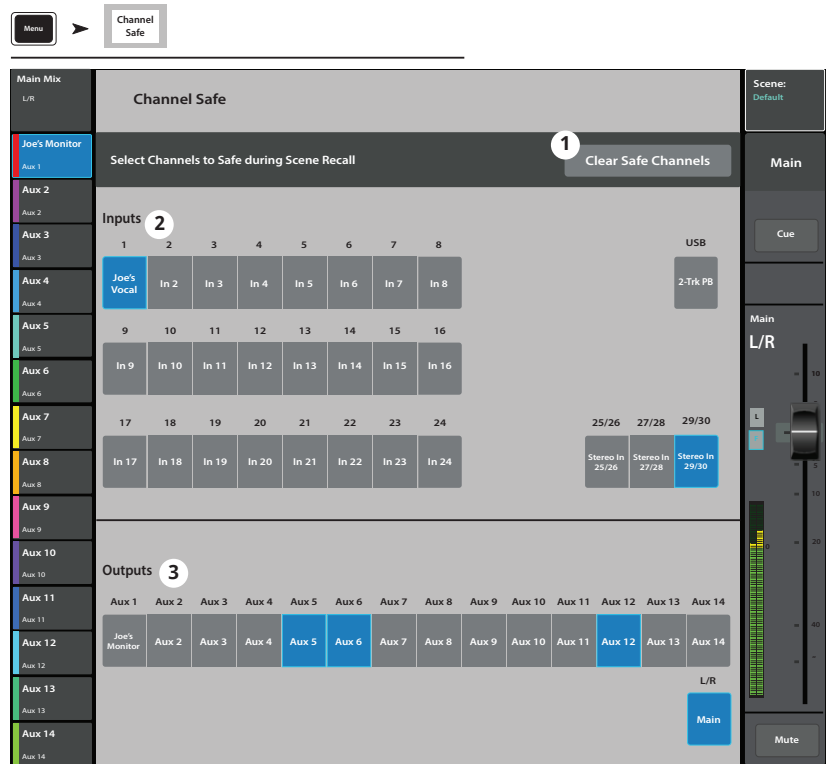

# Auto Mixer TouchMix -30 Pro

Automatic Microphone Mixer (TouchMix-30 only)

Menu  Auto-Mixer

## Description

An Automatic Microphone Mixer (Auto-Mixer) works by comparing the signal levels of the assigned channels and applying an algorithm that determines which talker (or talkers) is (are) currently speaking. The Auto-Mixer then sends a control command to the channels that allocates more gain to the channels with an active talker and less to the channels with an inactive talker. As a result feedback and extraneous noise (such as paper rustling from panelists or HVAC) are reduced. The Auto-Mixer simply rides gain on the assigned channels. It does not have any effect on signal routing. The Auto-Mixer will affect any Aux mixes that are assigned post-fader but will not affect pre-fader Aux sends.

Auto-Mixers are most commonly used for speech applications such as conferences, presentations or panel discussions in which there are multiple talkers and multiple microphones. They also may be used in theatrical sound reinforcement. Auto-Mixers are not intended to mix entire bands although they have been used successfully on horn sections and backing vocal ensembles.

The TouchMix-30 Automatic Microphone Mixer (Auto-Mixer) is a gain sharing design that is available for all 24 mic/line input channels. There are two independent Auto-Mixers.



## Accessing the Auto-Mixer

To access the Auto-Mixer: Menu > Auto-Mixer

It may be convenient to assign a User Button to the Auto-Mixer.

To assign a User Button to the Auto-Mixer: Menu > User Buttons > Select a button from User 1 – 8

1. In the Action panel, select Go To Screen
2. In the Selection panel, select Other
3. In the Detail panel, select Auto-Mix
4. Touch the Assign button

## Auto-Mixer Controls and Indicators

The Auto-Mixer Home Screen maintains the mixer's usual channel paradigm. Cue and Mute buttons function normally. The channel fader is shortened to allow room for Auto-Mixer controls. Controls are:

1. **Auto-Mix** – Enables (blue) or disables (gray) Auto-Mix for the channel. When disabled, the channel functions normally.
2. **1 and 2** – Two independent Auto-Mixers are available. These controls assign the channel to Auto-Mix group Auto-Mix 1 or Auto-Mix 2. A blue button indicates the group to which the channel is assigned.
3. **Sensitivity** – Adjusts the sensitivity of the channel to compensate for loud or soft spoken talkers.
4. **Auto-Mix 1 and Auto-Mix 2** switches –
  - a. Out (gray) disables the Auto-Mixer
  - b. In (blue) enables the Auto-Mixer
5. **Maximum Attenuation** – Sets the maximum attenuation that the Auto-Mixer will apply to the channels. For most applications this should be left at its default value of 60 dB. But there may be circumstances in which it is desirable to limit how much attenuation the Auto-Mixer will apply.
6. **Metering Mode** – There are two metering modes for the Auto-Mixer.
  - a. Gain Only – Displays a meter that indicates the total gain applied to the channel by the fader and the Auto-Mixer. The Gain meter is inactive when the associated channel is not assigned to the Auto-Mixer.
  - b. Level & Gain – Simultaneously displays the standard (green, yellow, red) channel signal-level meter on the left, and the Gain meter on the right (blue meter).

# External Control Surfaces - TouchMix -30 Pro

The TouchMix-30 Pro includes the capability to interface with third party control surfaces with motorized faders. QSC has verified operation with the following control surfaces. Refer to the documentation delivered with the control surface, or the company's website for connection and operation.

- **iCon Platform M+** – This controller offers the best match of features to the requirements of controlling the TouchMix-30 Pro and is recommended.
- **Behringer XTouch Compact** – Lacks some useful controls but is useable.
- **PreSonus FaderPort 8** – There are only eight faders so the master fader for the selected mix is not available on the control surface. All control of mixer outputs must be done on the TouchMix-30 Pro screen or app.
- **Other Control Surfaces** – Other current or discontinued control surfaces using MCP (Mackie Control Protocol) may work but QSC cannot provide any assistance for these devices.

## Channel Strip View

With physical faders in use, it is no longer necessary to display the graphic faders on the mixer or tablet screen. The channel strip view replaces the on-screen faders. There are two ways to display the Channel Strip view.



The channel strips present controls and indicators for the channels in the selected fader Bank.

1. **Channel Name / Select** – Displays the user-defined channel name and, when touched, displays one of the processing pages.
2. **Pan** – Indicates and controls placement of the channel in the stereo sound field.
3. **EQ** – Displays a graphic representation of the channel's EQ setting. Touch the image to go to the channel's EQ page.
4. **Track** – Selects a recorded track (USB multi-track or DAW depending on the Recording Mode setting) as the source for the channel.
5. **Arm** – If USB multi-track is selected as the recording mode, this control arms / disarms the track for recording.
6. **Comp** – Indicates whether the compressor is engaged / disengaged. Touch to navigate to the compressor screen. The meter to the right displays compressor activity.
7. **Gate** – Indicates whether the gate is engaged / disengaged. Touch to navigate to the gate screen. The meter to the right displays gate activity.
8. **48V** – Engages / disengages phantom power for the channel.
9. **Meter** – Indicates channel signal level.
10. **Assignments** – Indicates assignment to Main L/R and Sub Groups 8 – 1.
11. **Anti-FB** (output channels only) – Navigates to the Anti-feedback filters screen.

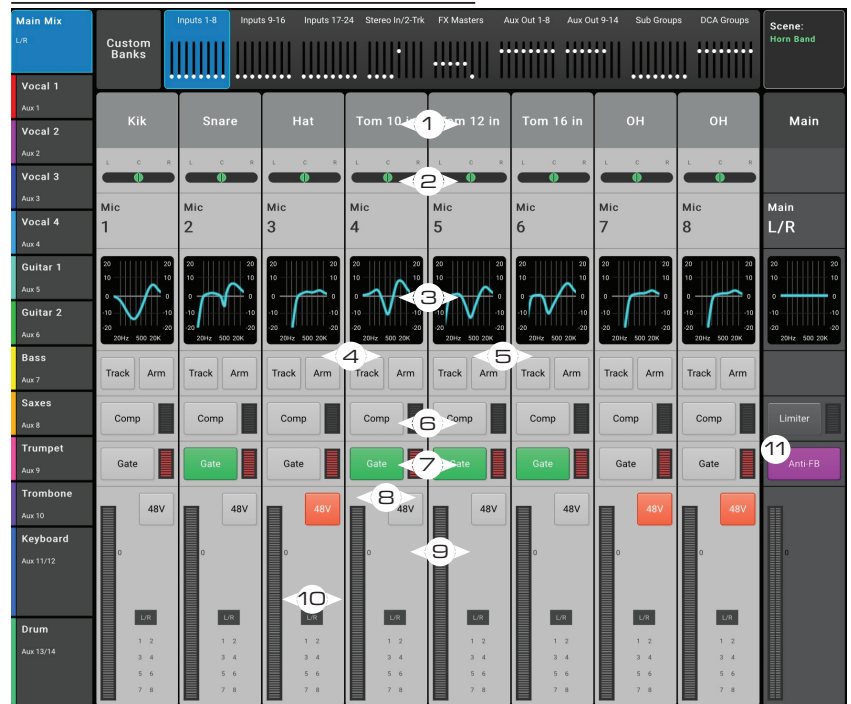

# Custom Fader Banks - TouchMix30- Pro

The TouchMix30- Pro mixer supports 3 Custom Fader banks. By default, the custom fader bank assignments are identical to the standard input fader banks – Inputs 8-1, Inputs 16-9 and Inputs 24-17. The customized banks are saved as part of the scene.

Press Menu  Press Custom Banks

## Set up the Custom Fader Banks

Press Menu > Custom Banks. The custom banks screen displays.

1. Press one of the Custom Bank tabs (1) to edit.
2. Use the Name field (2) to give the bank a custom name. This name displays in the Custom Bank tab (1). The characters you can use as the name are restricted to standard letters on the English (US) keyboard. If you select a restricted character, the following message displays.

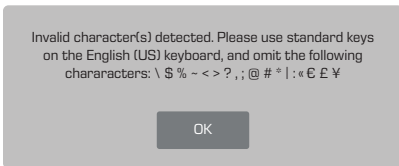

3. Each bank has eight Channel faders (3). Select a Channel fader button.
4. Select a channel (4) to assign to the selected Channel fader (3). Any of the following channels (4) may be assigned to the selected Channel fader: Inputs, Aux Masters, FX Returns, Sub Group Masters or DCA Group Masters. These channels may be assigned in any order.



**IMPORTANT!:** The assignment is effective immediately.

5. Press the Reset button to return all three Custom Banks to their default assignments.

## DCA Group Assignments

DCA Groups are used to vary the gain of several channels at once from a single fader without changing the position of the channel faders. DCA groups also include a mute function.

Press Home → Touch DCA Groups → Touch a DCA



**NOTE:** DCA Groups may also be accessed by touching Menu > DCA Groups.

### About DCA Groups

- When a channel is in one or more DCA Groups, the output of that channel is equal to the sum of the DCA fader settings and channel fader settings.
- When a channel is in one or more DCA Groups, the channel and all the DCA Groups must be unmuted for audio to pass. The same rule applies when a channel is in a DCA, and Mute Group – all must be unmuted for audio to pass.

1. **DCA Select button** – Selects the associated DCA group for editing.
2. **User-defined name field** – Touch the name field to display a keyboard that may be used to enter a name for the DCA Group.
3. **Clear Assignments button** – Clears all assignments from the selected DCA Group.
4. **DCA system name label** – This name does not change.
5. **Assignment buttons** – Touch one of the channel Assignment buttons to add the channel to the selected DCA Group. Inputs, outputs and FX returns may be assigned to DCA Groups.
6. **Main muted** – The orange color of the mute button indicates that the channel is muted from a group, such as DCA or Mute Groups.

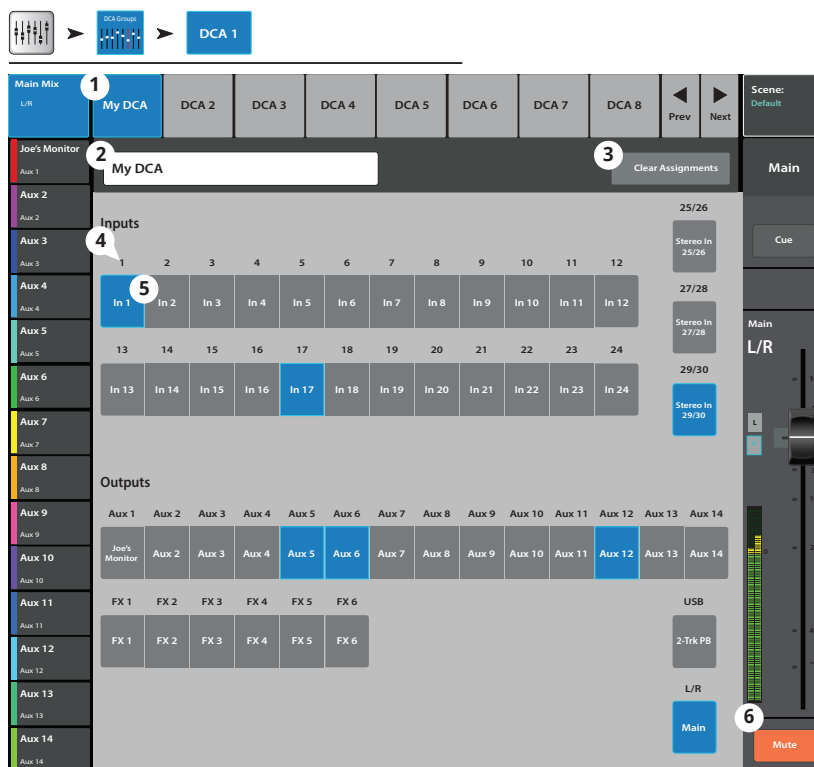

# MIDI

The MIDI (Musical Instrument Digital Interface) Setup provides the means to use a “class compliant” USB MIDI foot switch to control many functions of the TouchMix mixer. This screen is not available on remote devices.

QSC has verified proper operation with these USB MIDI foot-switches: iCON G-BOARD and Logidy UMI3

Press Menu  Touch MIDI Setup



**NOTE:** Only On/Off commands are supported. The mixer does not respond to continuous controller data.

1. **MIDI Functions** – The current MIDI assignments are displayed on MIDI buttons 1 – 8. Blue indicates the MIDI function is selected and can be assigned/unassigned or renamed.
2. **Name** – Displays the name of the currently assigned MIDI function. A name is automatically assigned when a function is selected in the Action, Selection, Detail fields.
3. **Assign button** – After making your selection, touch this button to assign your selection to the selected MIDI.
4. **Unassign** – Touch this button to remove the assignment to the selected MIDI.
5. **Action** – This list is a general list of types of things the MIDI controller can affect. For example “Recall Scene”.
6. **Selection** – When an Action is chosen, a list of ways the action can be applied are displayed. For example “Factory”.
7. **Detail** – Displays a list of specific targets for the selection. For example “Drum Sub Mix”.
8. **MIDI Assignment** – The name of the assignment made internally to the USB MIDI device button.
9. **Learn MIDI** –
  - a. Touch this button to teach the TouchMix what MIDI command should trigger the selected action.
  - b. A message displays saying, “Waiting for incoming MIDI message...”
  - c. Press a button on the USB MIDI device.
  - d. When the USB MIDI device button is pressed, the TouchMix responds by executing the assigned function.

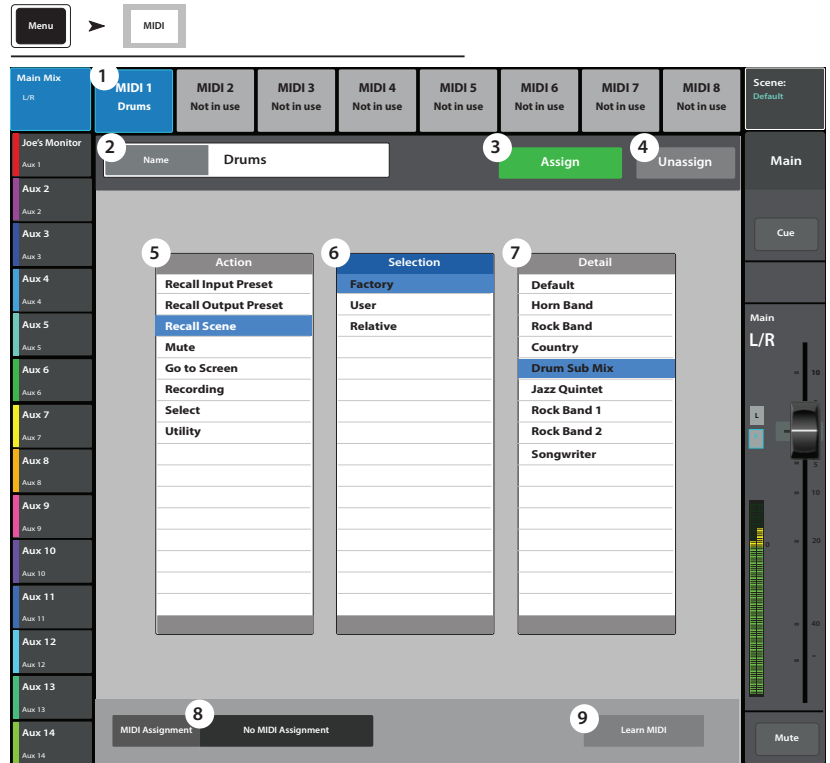



# Talkback / Noise

This screen controls the routing and level of Talkback and Noise.

Press Menu  Touch Talkback

1. **Reset button** — Restores factory defaults for the Talkback / Noise Generator.
2. **Assignment buttons** — Select the destination for the noise or talkback signals. Note that it is possible to route talkback to the FX devices. This is very useful when auditioning and selecting effects.
3. **Talkback (Measurement) Mic** — Adjusts the level of the talkback signal to the assigned outputs. -Inf (Infinity) is off.
4. **Enable (Talkback)** — Touch to enable Talkback, touch again to disable Talkback. Unlike the mixer’s hold-to-talk Talk button, this button is latching. When enabled, the hold-to-talk button is illuminated. On tablet devices, both Talk and Enable are latching.
5. **Mic Phantom** — Enables 48V phantom power to the Talkback microphone input.
6. **Noise Generator** — Adjusts the level of the noise signal to the assigned outputs. -Inf (Infinity) is off.
7. **Enable (Noise)** — Touch to enable Noise, touch again to disable Noise.

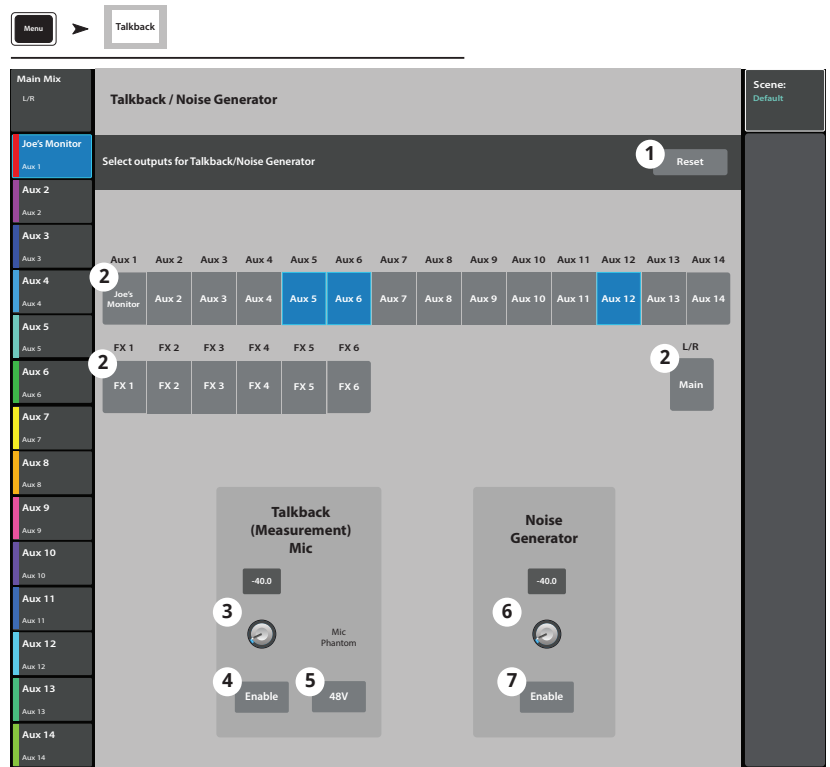

## TouchMix Wi-Fi Control

Manage the mixer's wireless or wired network. Connect an iPad, or iPhone (iOS 6 or later) or Android device (5.0 or later). The network configuration can only be performed on the TouchMix.

### Before You Begin

For smaller spaces with fewer potential sources of interference, a USB Wi-Fi Adapter such as that supplied with the TouchMix-8 and TouchMix-16 will work well. But USB adapters are going to have less range than external routers due to their lower-powered transmitters and tiny, less efficient antennas. In a larger space with more potential interference and more mission-critical remote control requirements it's better to have a higher-powered device with more efficient antennas. That's why there is no USB Wi-Fi Adapter included with the TouchMix-30 Pro – it's likely to be used in more demanding applications and an external Wi-Fi router is the best solution. That said, the TouchMix-30 Pro will work with the QSC-supplied USB Wi-Fi adapter marked with an "N". It is available here <https://parts.qsc.com/cp-000033-00> . But be aware that its range and connection reliability will be inferior to most external routers.

TouchMix mixers support multiple ways of connecting to your wireless devices.

### Wi-Fi Router Access Point

In this implementation, a Wi-Fi router wired to the mixer provides the access point to the mixer. The TouchMix-30 Pro connects directly to the router using CAT5 cable. TouchMix-8 and TouchMix-16 require an inexpensive **USB to Ethernet adapter** – for more information see <https://www.qsc.com/live-sound/resources/software-and-firmware/touchmix/ethernet/>.

- Advantages – Simple to set up. Good range and robust connection (depending on the Wi-Fi router). External routers will have higher power and far better antennae compared to a USB adapter. Many of them will also be able to operate in the less crowded 5 GHz channels. If the router has an Internet connection, it can alert you to and download firmware updates.
- Disadvantages – One more piece of gear to carry and connect.

### Setting it up

Unless you are skilled in digital network configuration, do not use a router with non-standard, custom settings. If using a multi-port router, do not connect the mixer to the Internet port (the Internet jack will usually be a different color than the other ports).



1. **Mixer Name** = Enter a mixer name
2. **Network Type** = Wired
3. **Wired Network Settings** = Auto IP Address (DHCP)
4. If the router is powered and properly connected, **Connection Status** = Connected
5. Touch **Apply**
6. The mixer configures the network and a message "**Wired Ethernet connection operational**" displays.
7. Touch **Okay**

Your devices will now connect to the mixer via the router using the router's SSID (router name) and password.

### Connecting to a Facility's Network

Networks in commercial facilities have been set up by IT professionals who are concerned about security. They may be very reluctant to allow you to connect a mixer to their network. But if they do, they will want to know two things.

What port do you want them to give you? Answer – any open port will work. The mixer will find it.

What services do you need? Answer – none. The mixer implements zero-configuration networking using Bonjour®.

## Wireless Network Setup: Create New Network



**IMPORTANT!** USB Wi-Fi adapter  
(QSC Part # cp-000033-00)

Press Menu ➤ Touch Network ➤ Touch Wireless

**Create New Network** using a USB Wi-Fi dongle provides short range wireless communication between the TouchMix mixer and Android and/or iOS devices with the TouchMix app installed.

1. **Mixer Name:** – Enter a name for the network.
2. **Network Type:** – Set to **Wireless**.
3. Select **Create New Network**.
4. **Set Network Password:** – Enter a ten-digit (numerical) password.
5. **Apply** – Touch to configure the network. The network is ready for use. External devices may now login to the mixer using the **Mixer Name** and **Password**.

Menu ➤ Network ➤ Wireless

Network Setup

Mixer Name: My TM-30 Network Type: Wireless Wired

Wireless Network Settings

Connect to Existing Network Create New Network

Set Password: 0123456789

Apply

## Wireless Network Setup: Connect to Existing Network



**IMPORTANT!** Requires an Ethernet Wi-Fi router and the USB Wi-Fi adapter (QSC Part # cp-000033-00).

Press Menu → Touch Network → Touch Wireless

### Connecting to an Existing Network

using a USB Wi-Fi dongle provides short range wireless communication between a TouchMix mixer and a longer range wireless Ethernet router. The Android and/or iOS devices with the TouchMix app installed communicate with the TouchMix via the Ethernet wireless router.

1. **Mixer Name:** – Enter a name for the mixer.
2. **Network Type:** – Set to **Wireless**.
3. Select **Connect to Existing Network**.
4. **Network SSID:** – Enter a known SSID of an Ethernet wireless router, or touch Scan. Select the desired network from the list that displays.
5. **Scan** – The mixer searches for, and displays, a list of available wireless networks. Select the desired network.
6. **Password:** – Enter the password for the network being joined.
7. **Security:** – Select the Security setting used by the network.
8. **Apply** – Touch to configure the mixer. External devices may now log on to the mixer using the external network Name and Password.

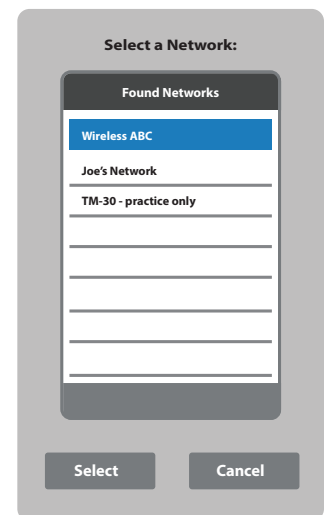
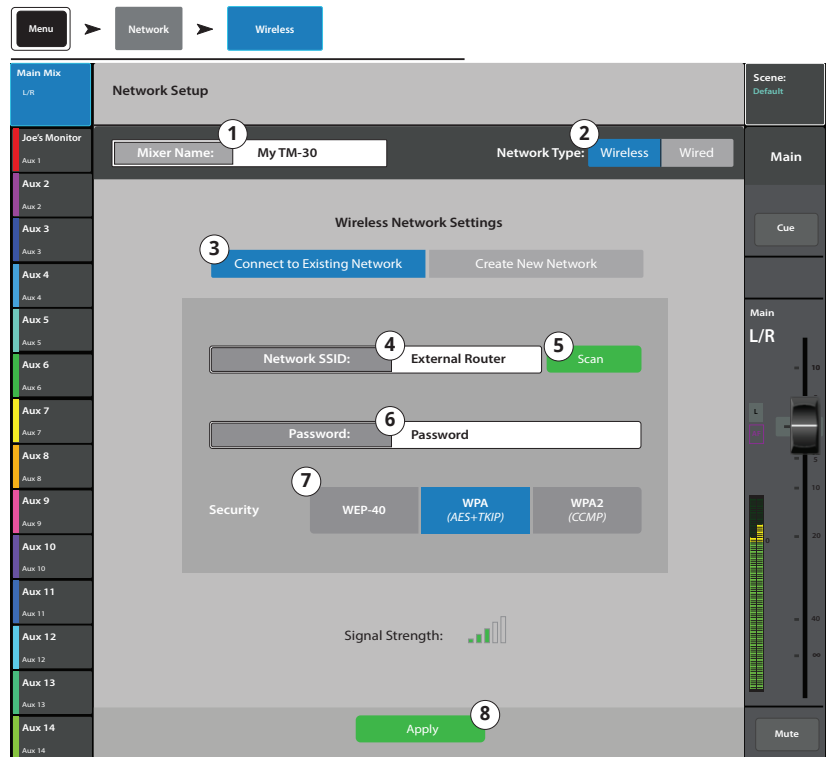

## Wired Network Setup: Static IP Address

Press Menu ➤ Touch Network ➤ Touch Wired



**IMPORTANT!** For TouchMix-30 Pro, connect an Ethernet router to the mixer's RJ45 jack. For TouchMix-8 and TouchMix-16 connect a compatible USB to Ethernet adapter to the mixer's USB port. (for compatible adapters, visit [qsc.com](http://qsc.com) and search for "Ethernet").

Using a **Wired Network Setup** with a **Static IP Address** provides wired communications between a TouchMix and a wireless Ethernet router. Make sure there is no other equipment connected to the same network with the same IP address.

1. **Mixer Name:** – Enter a name for the network.
2. **Network Type:** – Set to **Wired**.
3. Select **Static IP Address** to use a static IP address for the mixer.
4. Enter the **Network Address** for the mixer.
5. Enter the **Network Mask**
6. Enter the **Gateway Address**
7. **Connection Status:**
  - a. **Connected** – Displays to confirm successful connection to the network. External devices may now login to the mixer using the external network Name and Password.
  - b. **No Cable Detected** – Mixer is not connected to a network.
8. **Apply** – Touch apply and the mixer will configure the network connections. .

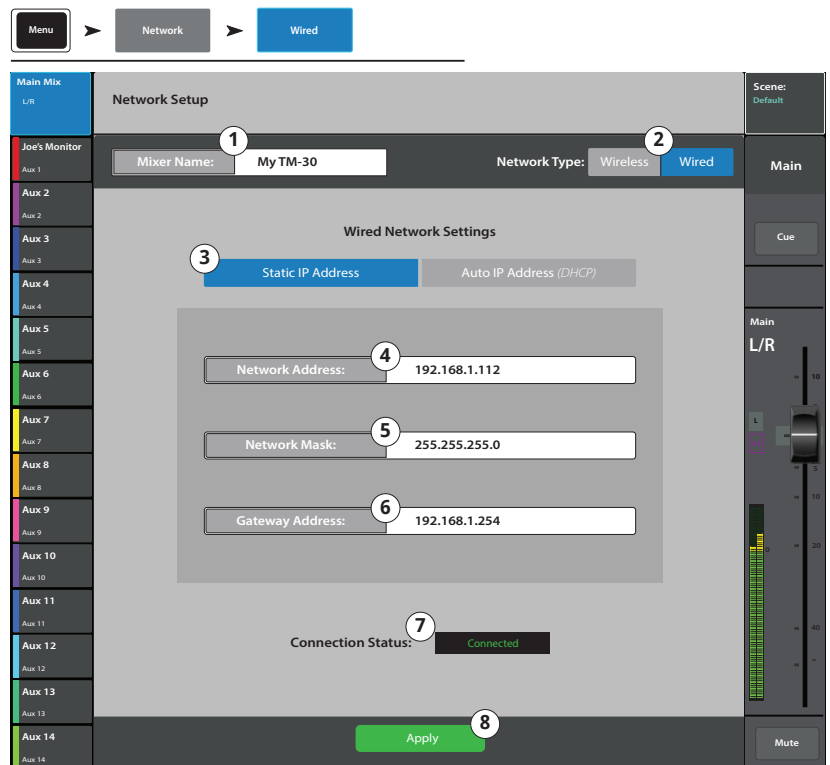

## Wired Network Setup: Auto IP Address (DHCP)



**IMPORTANT!** For TouchMix-30 Pro, connect an Ethernet router to the mixer's RJ45 jack. For TouchMix-8 and TouchMix-16 connect a compatible USB to Ethernet adapter to the mixer's USB port. (for compatible adapters, visit [qsc.com](http://qsc.com) and search for "Ethernet").

Press Menu ➤ Touch Network ➤ Touch Wired

Using a **Wired Network Setup** with a **Auto IP Address (DHCP)** provides wired communications between a TouchMix and a wireless Ethernet router. The DHCP provides an unused IP address for the TouchMix. It may be different each time you connect to the network.

**Mixer Name:** – Enter a name for the network.

1. **Network Type:** – Set to **Wired**.
2. Select **Auto IP Address (DHCP)** to set the IP Address automatically.
3. The mixer searches for an IP address from the network and enters it in the **Assigned IP Address** field.
4. **Connection Status:**
  - a. **Connected** – Displays to confirm successful connection to the network. External devices may now login to the mixer using the external network Name and Password.
  - b. **No Cable Detected** – Mixer is not connected to a network.
5. **Apply** – Touch apply and the mixer will configure the network connections.

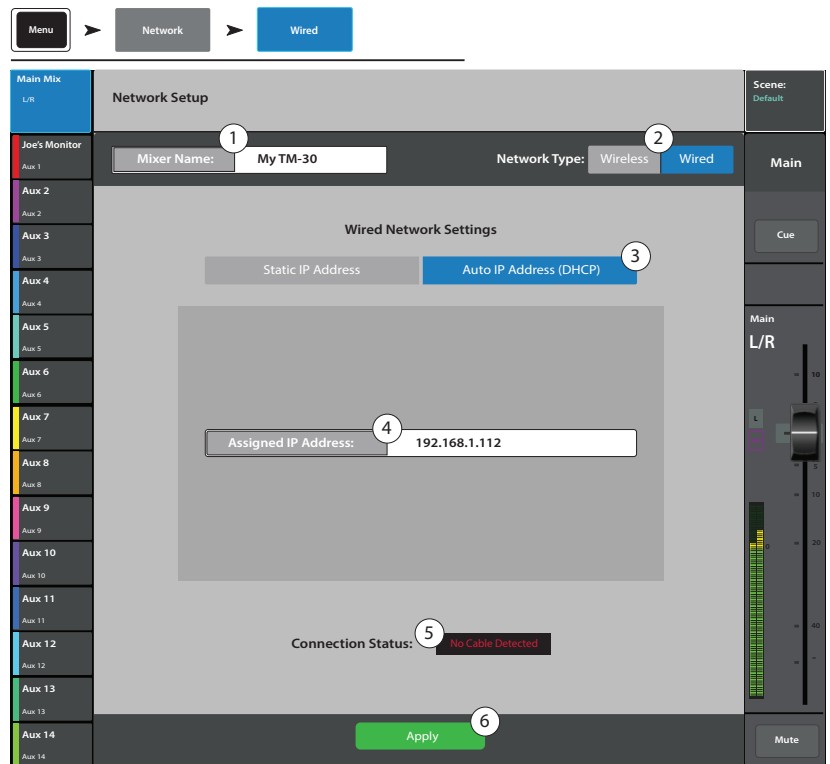

# TouchMix -30 Pro Phones and Monitor

Phones and Monitor Level Control and Monitor settings.

Press Phones OR Press Monitor



**NOTE:** By default, no audio signal is sent to the Phones / Monitor Outputs. To send audio channel signals (including Main L/R) to the Phones / Monitor Outputs. Enable the Cue button for the channels you want to listen to.

## Phones Level

1. **Phones / Cue Level** — Controls the level of the signal on the Phones outputs.

## Monitor Level and Settings

1. **Source** (Monitor) – Select the source you want to send to the Monitor output.
2. **In** – Engages / bypasses the delay.
3. **Delay** – The delay is used to align the audio coming from a distant stage with the near-field monitor signal heard at the mixer position. Digital readouts are in feet, milliseconds, and meters.
4. Adjust the output level for the Monitor.

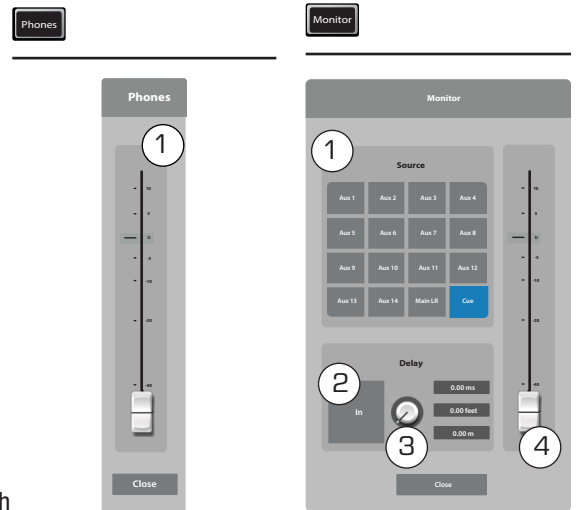

# TouchMix -8 and TouchMix -16 Phones and TouchMix -16 Monitor

Controls the output level for the Phones Cue and Monitor Cue

Press Phones OR Press Monitor



**NOTE:** The Monitor Level control is available only on the TouchMix-16.

**Phones (1) and Monitor (2) Level** – Controls the level of the Cue signal on the Phones and Monitor outputs.



**NOTE:** By default, no audio signal is sent to the Phones / Monitor Outputs. To send audio channel signals (including Main LR) to the Phones / Monitor Outputs. Enable the Cue button for the channels you want to listen to.

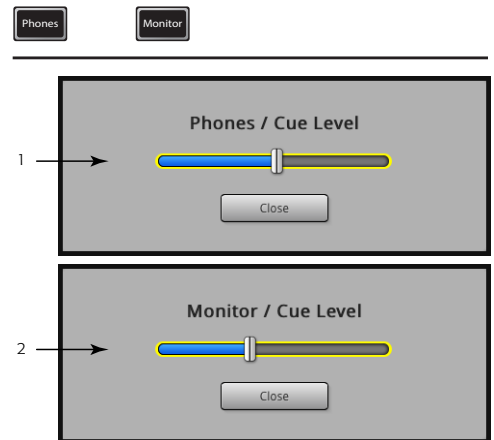

# Recording Setup – Multitrack USB

Recall, initiate, and manage Multitrack recording sessions. Scroll down for Recalling a session.



1. **Current Session** – Displays the name of the currently active session.

2. **New Session** –



**NOTE:** When a new session is created, it is made the “**Current Session**”.

- a. **New Session** button – Touch to start creating a new session.
- b. **New Session Name** dialog – Touch the edit field to enter a name for the new session.



**NOTE:** You cannot create a new session named “DEFAULT” or rename “DEFAULT”.

- c. **Create** button – Touch to create (save) the New Session. A dialog displays asking if you want to create a new session named “<your session name>”. Touch Yes to create, or Cancel.

3. **Rename** –

- a. In the USB Sessions list, select the session you want to rename.
- b. **Rename** button – Touch to change the name of the selected session.
- c. **Rename Current Session To:** dialog – Touch the edit field to rename the selected session.
- d. **Rename** button – Touch to save the renamed session.

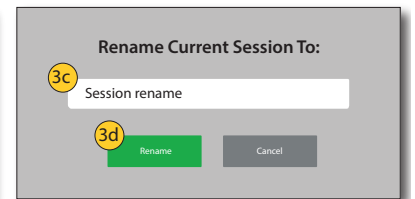
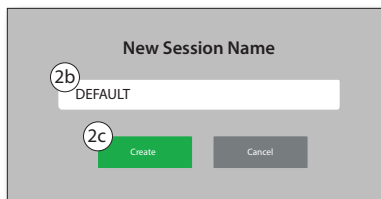
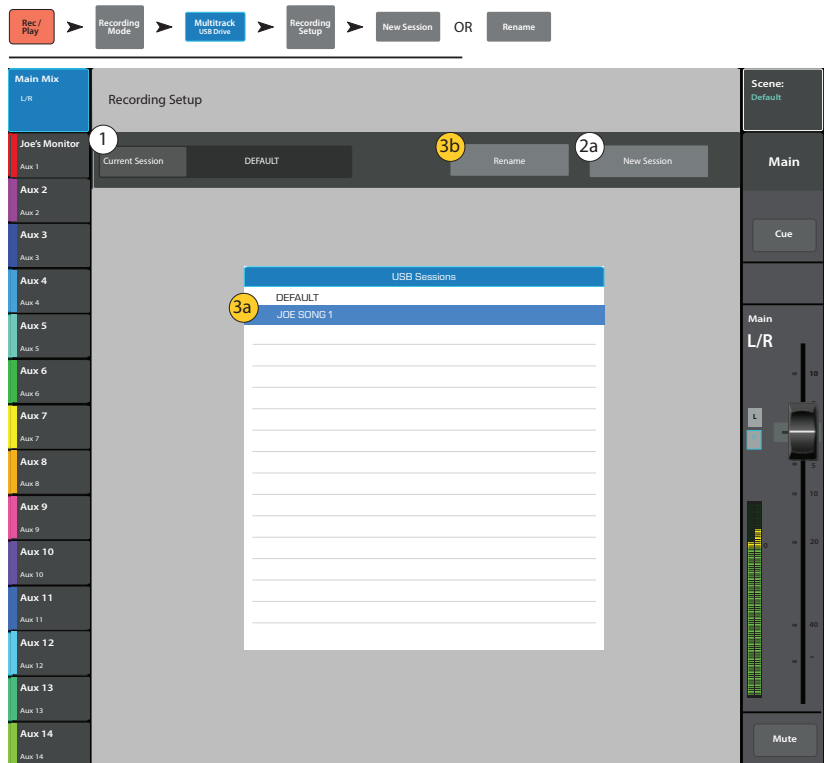

To return to the main Record / Play screen, press Rec/Play.



# Recall Session – Multitrack USB

Recalls multi-track sessions from a USB drive.

Recalling a Multitrack USB session tells the mixer to record in an existing recording file structure on the inserted USB drive. Each time recordings starts and stops, a .wav file is created in any subdirectory associated with armed tracks.



**IMPORTANT!:** Formatting the USB drive will remove all data on the drive.

1. **USB Sessions** – Displays a list of all USB recording sessions on the USB drive in the Mixer USB port. Touch a USB session name to recall.
2. **Record Pick\_Off** –
  - **Pre** – Recorded audio is not affected by the dynamics or EQ processors.
  - **Post** – Recorded audio is affected by the dynamics and EQ processors.
3. **Format USB Drive** – Formats the currently installed USB drive in the Mixer’s USB port.
4. **Recall** – Touch to recall the selected USB Session.

To return to the main Record / Play screen, press Rec/Play

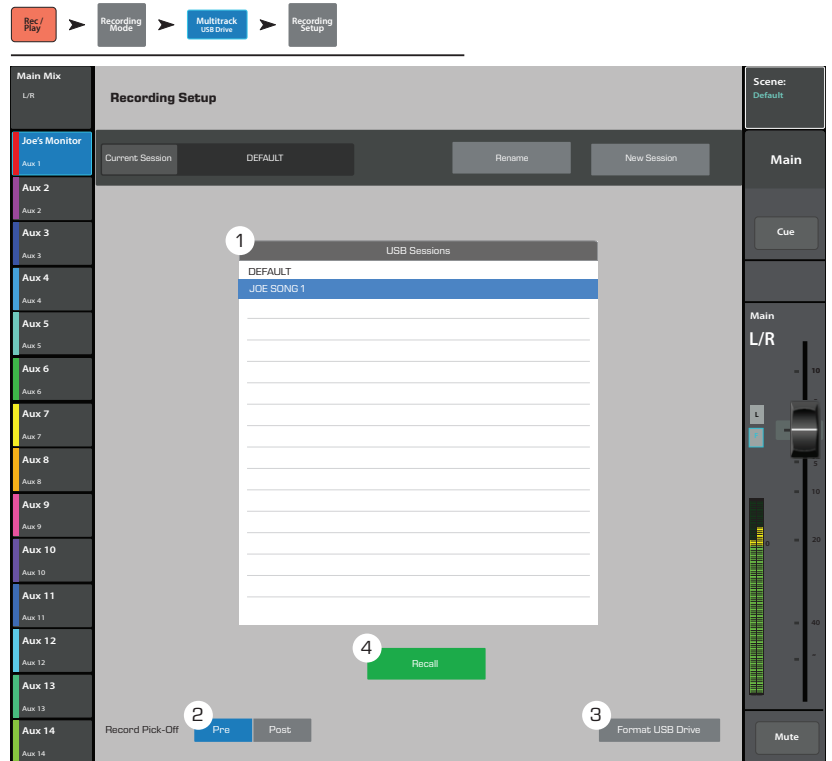

## Aux Mix on Faders

The Aux Mix on Faders provides a view of a single Aux Mix (or Aux Bus) with large faders. By selecting different fader banks, you can see and adjust everything that is sent to the selected Aux bus.

Press Home → Select a Fader Bank → Select an Aux Mix

Here is an example.

1. Select fader bank Inputs 1–8 (1)
2. Select Aux 1 (2)
3. The faders you see (6) are the Aux Sends from Input channels 1–8 going to Aux Mix 1.
4. Select FX Masters (1).
5. The faders you see are the Aux Sends from the FX Masters going to Aux Mix 1.
6. Notice that when you select Aux Mix 1 some of the small white faders in the fader banks are missing. These channels are not available to the selected Aux Mix. The channels that are not available to the Aux Mix are the Aux channels.



## TouchMix-30 Pro

The TouchMix-30 Pro is a little different. For Aux Mixes 1–8 it is the same as TouchMix-8 and TouchMix-16. However, if you select Aux Mix 9–14 you will notice that Aux channels 1–8 are now available. This means that you can send an already-mixed Aux output (any or all of Aux Mixes 1–8) to one or more of the Aux Mixes 9–14.

TouchMix-30 Pro Auxes are doing double duty as Mix Matrices. A Mix Matrix lets the operator take existing main, auxiliary and sub group mixes and create a new mix from them.

## Summary

Here's what can be mixed on to the Auxes:

- **Auxes 1–8:** All TouchMix models – All Inputs, all Effects / TouchMix-30 Pro Only – Main L/R, all Sub Groups
- **Auxes 9–14:** (TouchMix-30 Pro Only) All Inputs, all Effects, Main L/R, all Sub Groups, Auxes 1–8



**NOTE:** To add the Main L/R to an Aux Mix, select Aux Out 9–14 fader bank.

## Control Descriptions:

1. **Fader Bank selectors** – Touch a Fader Bank number to display the selected Aux Mix for the selected Fader Bank.
2. **Aux Mix select buttons** – Select an Aux Mix to display that Aux Mix for the selected Fader Bank.
3. **Channel select and friendly name** – Touch a channel selector to access all the details for that channel. You can change this name in the channel's Setup screen.
4. **Cue buttons** – Sends signal from the channel input to the Phones and/or Monitor outputs.
5. **System Channel Name labels** – 1 Mic, 2 Mic, and so on, do not change.
6. **Aux Send faders** – Adjusts the audio level of the selected channel to the selected Aux Mix. Color coded to match the Aux Mix Select buttons.
7. **Channel Input meter** – Displays the pre-fader / post-compressor & gate audio level of the channel.
8. **Aux Mix Master fader** – Adjusts the overall level of the selected Aux Mix. This level includes all Aux Sends to this Aux Mix. Changes when a different Aux Mix is selected.
9. **Mute buttons** – Mutes the Aux Send only for the associated channel.
  - Orange: Indicates that the channel is muted from the Main L/R mix, a mute group or a DCA group.
  - Red: Indicates the channel is muted for the selected Aux mix.



## Copy and Paste

The TouchMix-30 Pro has a powerful but simple copy and paste function that is operated by the U7 (copy) and U8 (paste) buttons. Copy and Paste is context sensitive so that what you are looking at is what will be copied. Only like things may be copied and pasted from and to each other. For example, a PEQ cannot be pasted to a GEQ. The table below explains what parameters will be copied and pasted.



**NOTE:** The copy buffer retains the last item of each type that has been copied. If, for example a GEQ setting is copied and then a Gate is copied, both will reside in memory. If a GEQ is displayed, Paste will recall the copied GEQ parameters. If a Gate is displayed, Gate parameters will be pasted.

To Copy and Paste Parameters:

- Navigate to the screen that displays the values to be copied.
- For the TouchMix-30 Pro – **Press U7**, for the TouchMix-8 and TouchMix-16 – **Press U2** (Copy)
- Navigate to the destination screen.
- TouchMix-30 Pro – **Press U8**, TouchMix-8 and TouchMix-16 – **Press U3** (Paste)

Let's say you want to copy the mix that's on Auxiliary 1 to Auxiliary 5...

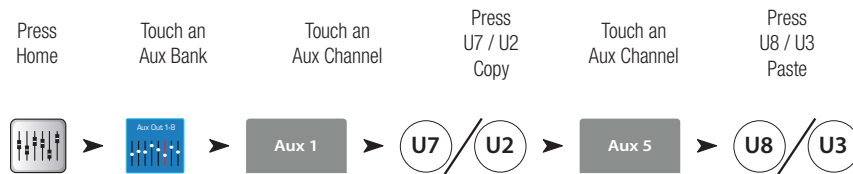

After set-up is complete, it may be useful to clear the Copy/Paste buffer. This will prevent accidentally pasting parameters during the show. To clear the Copy / Paste memory:

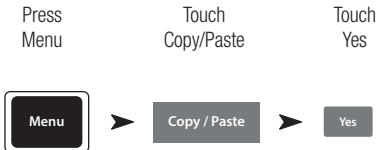

### What is Displayed

### What is Copied and Pasted

What is Displayed	What is Copied and Pasted
Main or Auxiliary Faders View	Fader, Mute and Pan
Input Channel Overview Tab	EQ, Compressor, Gate, FX sends, Aux Sends, Digital Gain, Delay, Group Assigns, Polarity
Input Channel EQ Tab	All channel EQ parameters
Input Channel Comp Tab	All channel Compressor parameters
Input Channel Gate Tab	All channel Gate parameters
Input Channel FX Tab	All channel FX send levels
Input Channel Aux Tab	All channel Auxiliary Send levels and Pan positions
Input Channel Setup Tab	Recording Arm, Polarity, Delay, Digital Gain, Group assignments
Output Channel Overview Tab	PEQ, Limiter, FX sends, Aux Sends, Delay, Group Assigns, Polarity, Pick-Off Point (Auxes only)
Output Channel PEQ Tab	All channel PEQ parameters
Output Channel GEQ Tab	All channel GEQ parameters
Output Channel Anti-Feedback Tab	All channel Anti-feedback parameters

**What is Displayed****What is Copied and Pasted**

Output Channel Limiter Tab	All channel Limiter parameters
Output Channel FX Tab	All channel FX send levels
Output Channel Aux Tab	All channel Auxiliary Send levels and Pan positions
Output Channel Setup Tab	Recording Arm, Polarity, Delay, Digital Gain, Group assignments
FX Channel Overview Tab	Current Preset, EQ, Pick-Off Point, Group Assigns, Polarity
FX Channel EQ Tab	All FX channel EQ parameters
FX Channel Preset Tab	Processor and Preset selection, FX Returns and Pans to Aux
FX Channel Aux Tab	All FX Channel Auxiliary Send levels and Pan positions
Sub Group Overview Tab	PEQ, Limiter, FX sends, Aux Sends, Group Assigns
Sub Group EQ Tab	All Sub Group PEQ parameters
Sub Group Limiter Tab	All Sub Group Limiter parameters
Sub Group FX Tab	All Sub Group FX send levels
Sub Group Aux Tab	All Sub Group Auxiliary Send levels and Pan positions

# TouchMix-30 Pro

## Firmware Version 3.0 Features

### Scenes, Snapshots and Cue Lists

These functions provide the ability to save, recall and manage settings.

#### Scenes

Scenes store and recall all mix parameters.

1. **Current Scene** - Displays the name of the most recently recalled scene.
2. **Update** - Updates the Current Scene to include any change made since it was recalled. A confirmation dialog will appear.
3. **Info** - Displays a field containing a user-entered description of the scene.
4. **Save / Save As** - Opens a pop-up where a scene may be named / renamed and a description entered before saving.
5. **Factory / User** - Determines if the available scenes are from the factory preset library or a user library.
6. **App Storage (tablet only)** - Displays a list of scenes that have been stored to the tablet's internal memory. Note that these scenes must be copied to the Mixer Internal memory before they can be recalled.
7. **Mixer Internal** - Displays a list of scenes that have been stored to the mixer's internal memory.
8. **USB External** - Displays a list of scenes that have been stored to attached USB storage media.
9. **Copy To ...** - Copies a selected scene between app, mixer and USB memory.
10. **Delete** - Removes the selected scene from memory.
11. **Recall Omits** - Prevents scene recall from changing some settings...
  - **Omit Levels** - Mix levels, Aux sends, FX sends and output levels are unaffected.
  - **Omit Outputs** - Main and Aux output processor settings are unaffected.
  - **Omit Routing** - Sub Group and Main L/R assignments are unaffected (shown in "Omit" position).
12. **Recall** - Recalls the selected scene. App Storage scenes must first be copied to Mixer Internal memory.

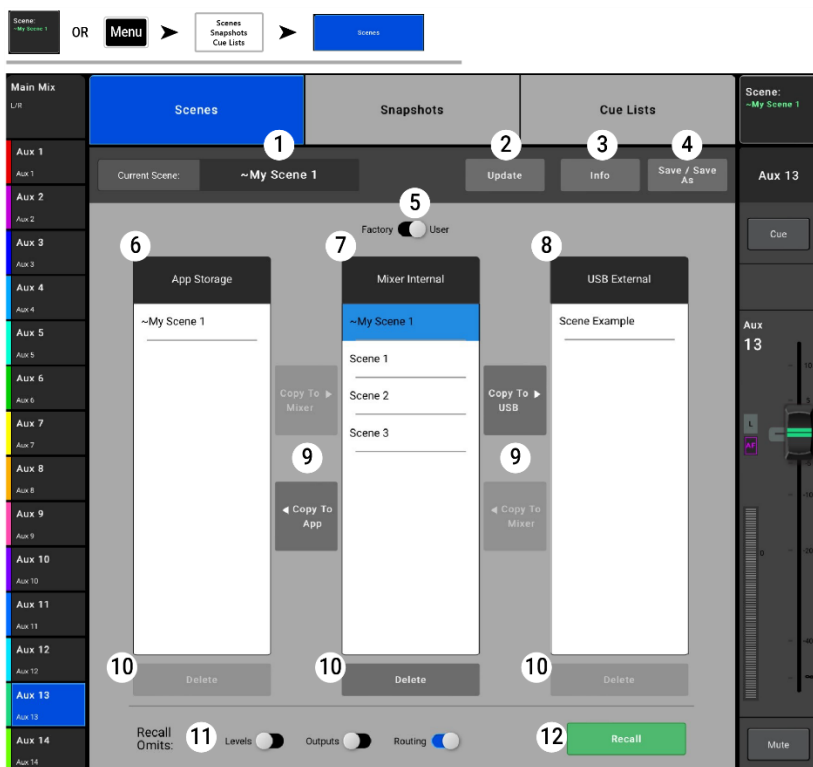

## Snapshots

Snapshots allow the user to save and recall selected settings for designated channels without affecting other mixer settings. Snapshots are far more granular than Scenes.

1. **Save Snapshot As** - This field is present when filters are accessed from New / Save As and may be used to enter a new name for the Snapshot.
2. **Description** - This field is present when filters are accessed from New / Save As and may be used to enter a new description for the Snapshot.
3. **Channel Selection** - These buttons determine which channels (Inputs, Outputs, Effects, Sub Groups, DCA, Sends) are displayed below.
4. **Include Switch** - Set to "Include" if filters from that channel group are to be part of the snapshot.
5. **FX & Aux Sends** - When the Input Channel filter selection includes FX Sends and/or Aux Sends, these filters determine which ones.
6. **Filter Selections**
  - The upper area of the screen presents the channel selections for the selected type of channel.
  - The lower area of the screen presents the parameters that may be included in a snapshot.
7. **Select All, Select None** - Self explanatory.
8. **Clear All** - Removes all Filter selections.
9. **Save** - This field is present when filters are accessed from Save / Save as.

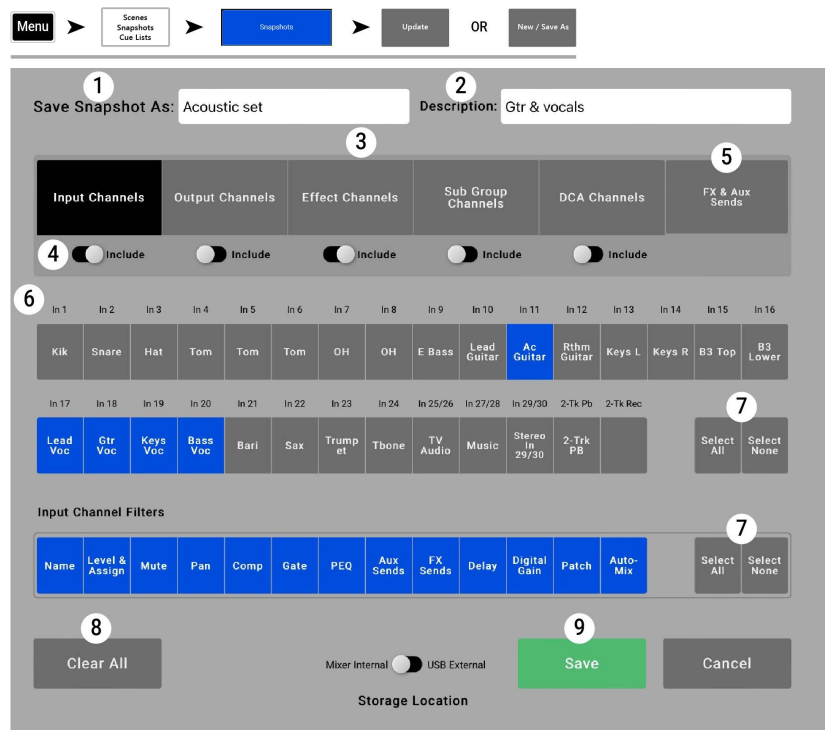

## Cue Lists

Cue Lists are used to select and arrange scenes, snapshots and audio files for recall on cue during a show.

1. **Current Cue List** - Displays the name of the active Cue List.
2. **Save / Recall** - Opens a window where an existing Cue List may be recalled or a new Cue List may be named and saved. Operation is similar to the Scenes Save / Save As functions described above.
  - App Storage - (App only) A Cue List and its associated Scenes and Snapshots may be saved to or copied from a tablet's internal memory.
3. **Assets Window** - At the top of the Assets Window are buttons that select the type of asset (Scenes, Snapshots or Audio Files) to be displayed.
  - The Scenes and Snapshots lists consist of those items that have been stored to the mixer's internal memory.
  - The Audio Files must be stored to the root directory of an attached USB drive, have a sample rate that matches the mixer's current settings and be in MP3 or Wave format.
4. **Add To Cue List** - Adds the selected Asset to the end of the Cue List.



**TIP:** When building a Cue List, it's a good practice to begin with a Scene so there is a known starting point. Some snapshot settings may deliver unwanted results when applied to a mixer with non-scene settings that differ from those in place when the scene was created.

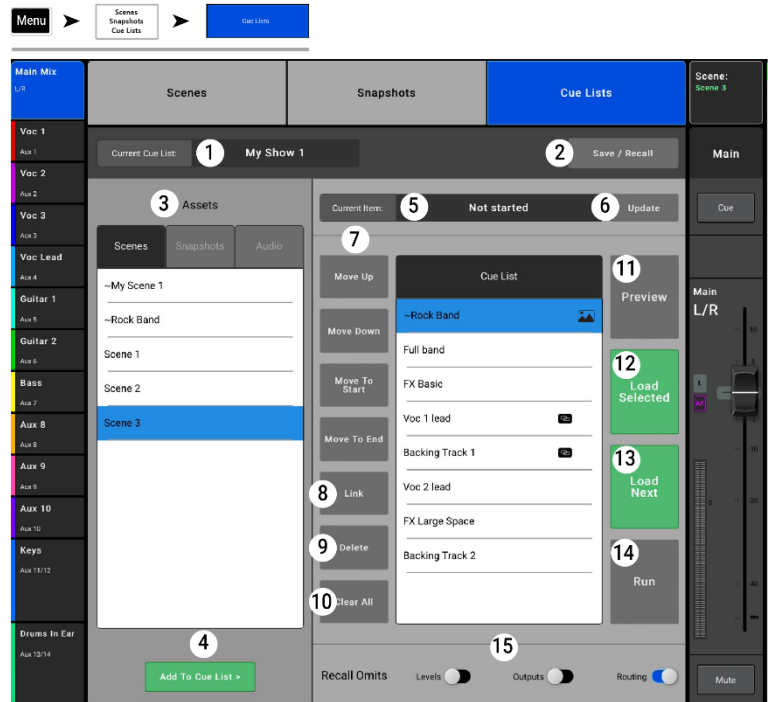

5. **Current Item** - Displays the name of the most recently loaded (recalled) Cue List item.
6. **Update** - Updates the most recently recalled scene or snapshot to reflect the current state of the mixer's settings. A confirmation dialog will appear.
7. **Move Buttons** - These controls are used to rearrange Cue List items.
8. **Link Button** - Ties a selected Cue List item to the item immediately below it allowing both Cues to be loaded simultaneously.
9. **Delete** - Removes the selected item from the Cue List. Does not affect the Assets.
10. **Clear All** - Removes all items from the Cue List. Does not affect the Assets.
11. **Preview (snapshots only)** - Displays the filter settings for the selected snapshot.
12. **Load Selection** - Loads (recalls) the selected Cue List Item.
13. **Load Next** - Loads (recalls) the selected Cue List Item.
14. **Run** - Opens the Cue List Run screen. This screen includes many of the controls found on the Cue List Edit screen but omits those controls used to add, delete or rearrange assets.
15. **Recall Omits** - See Scenes above.
16. **Edit** - Returns to the Cue List edit screen.

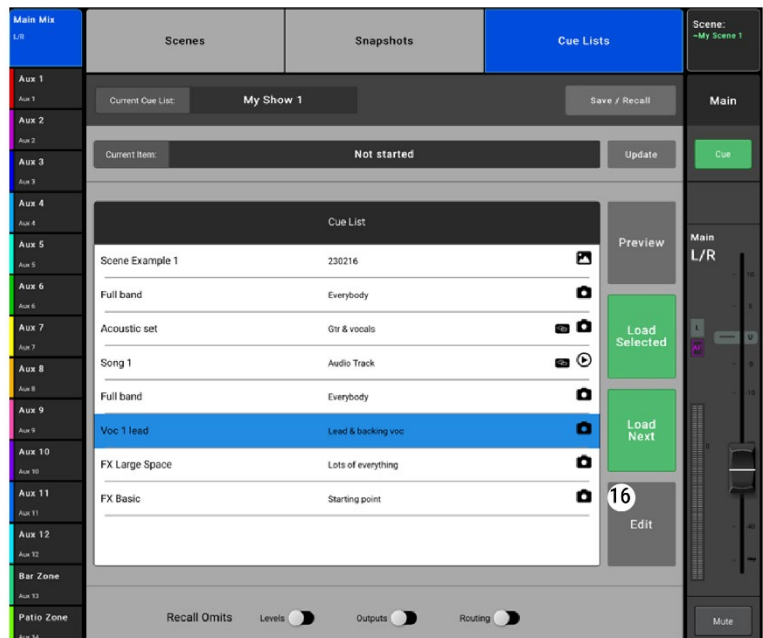



# TouchMix Dimensions

## TouchMix-30 Pro

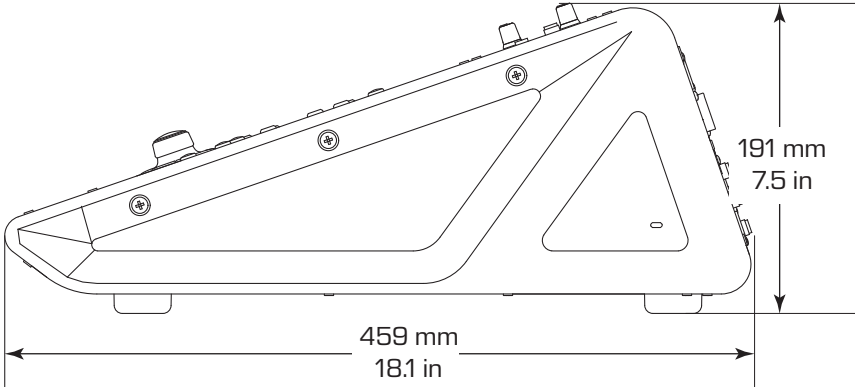
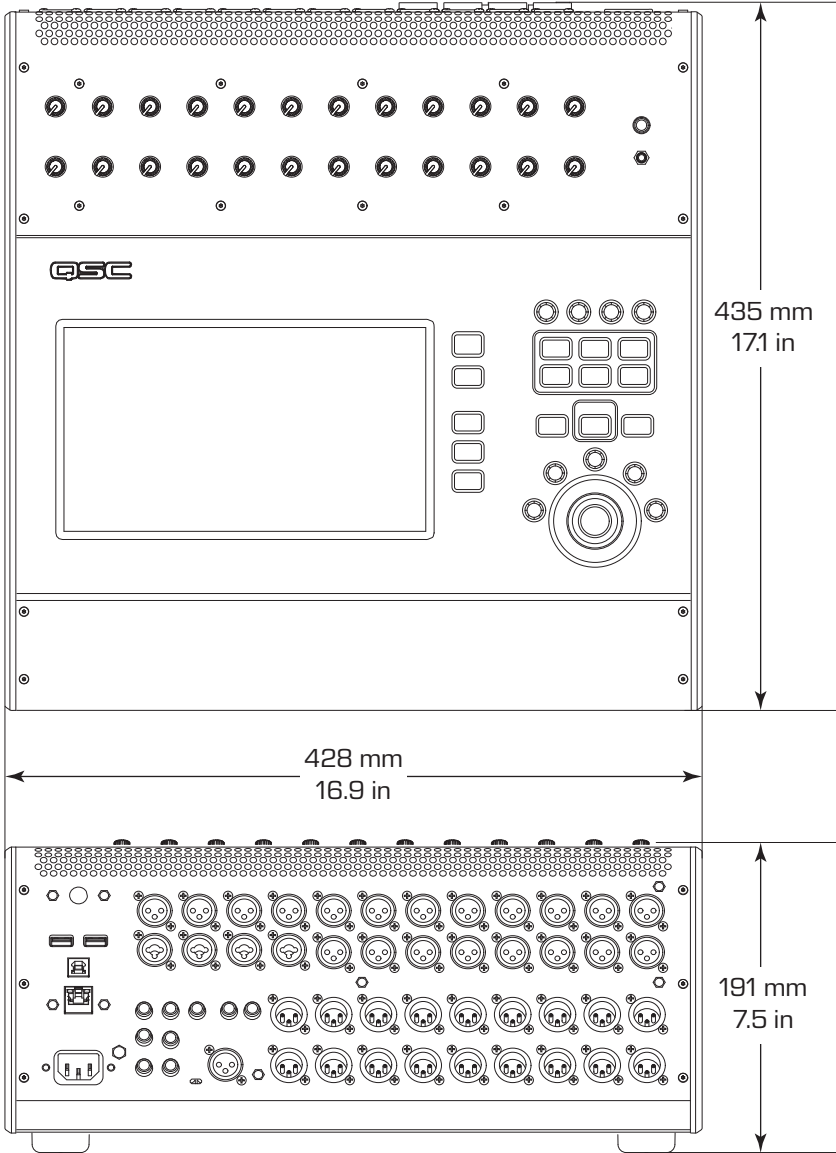

# TouchMix-8

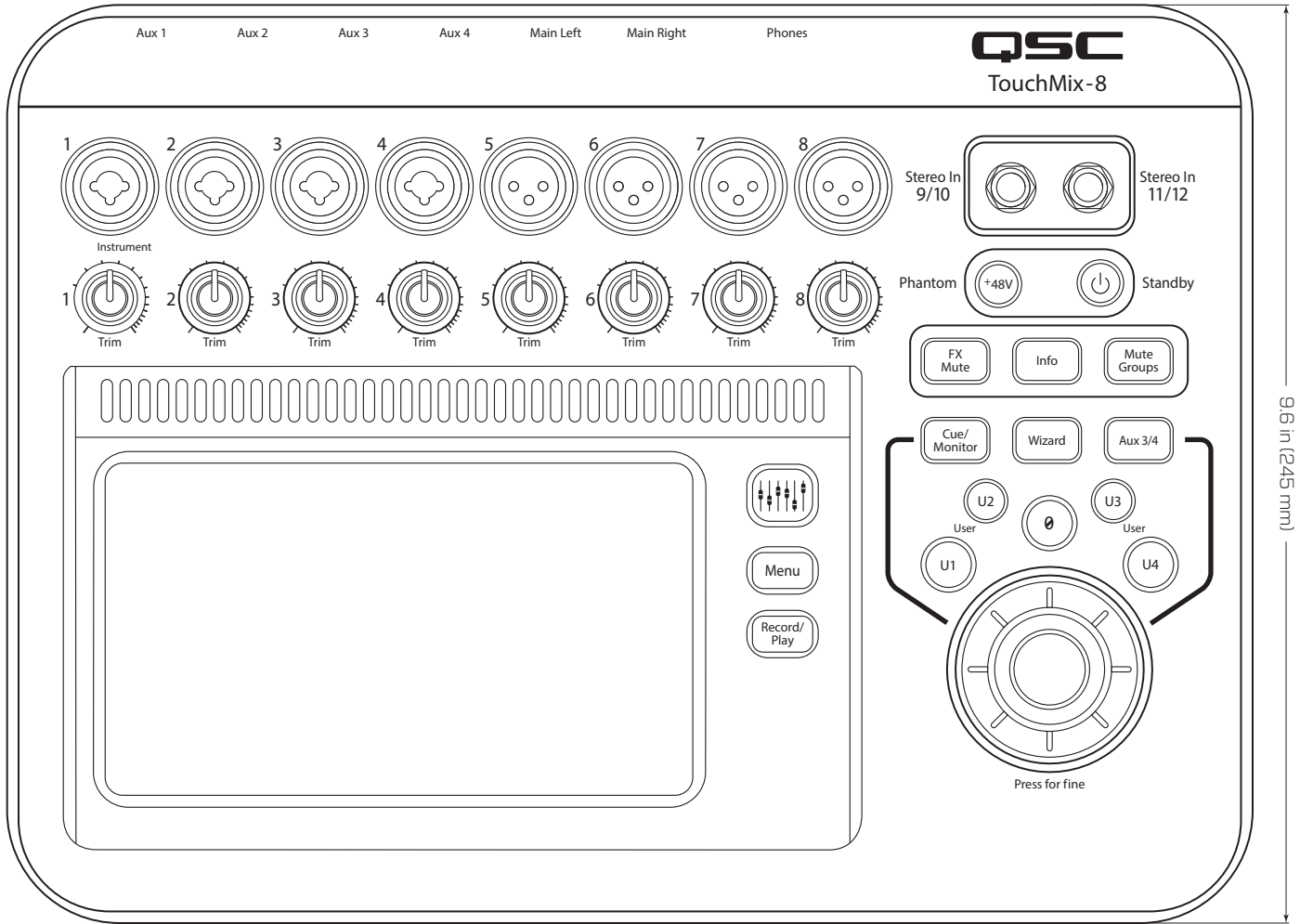
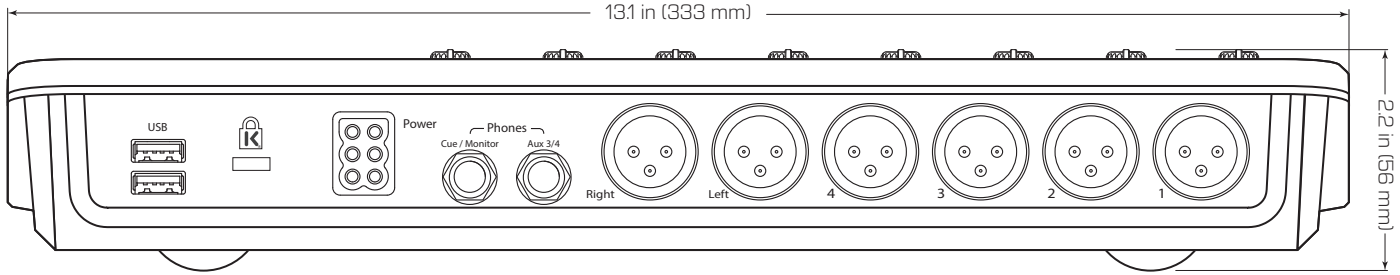

# TouchMix-16

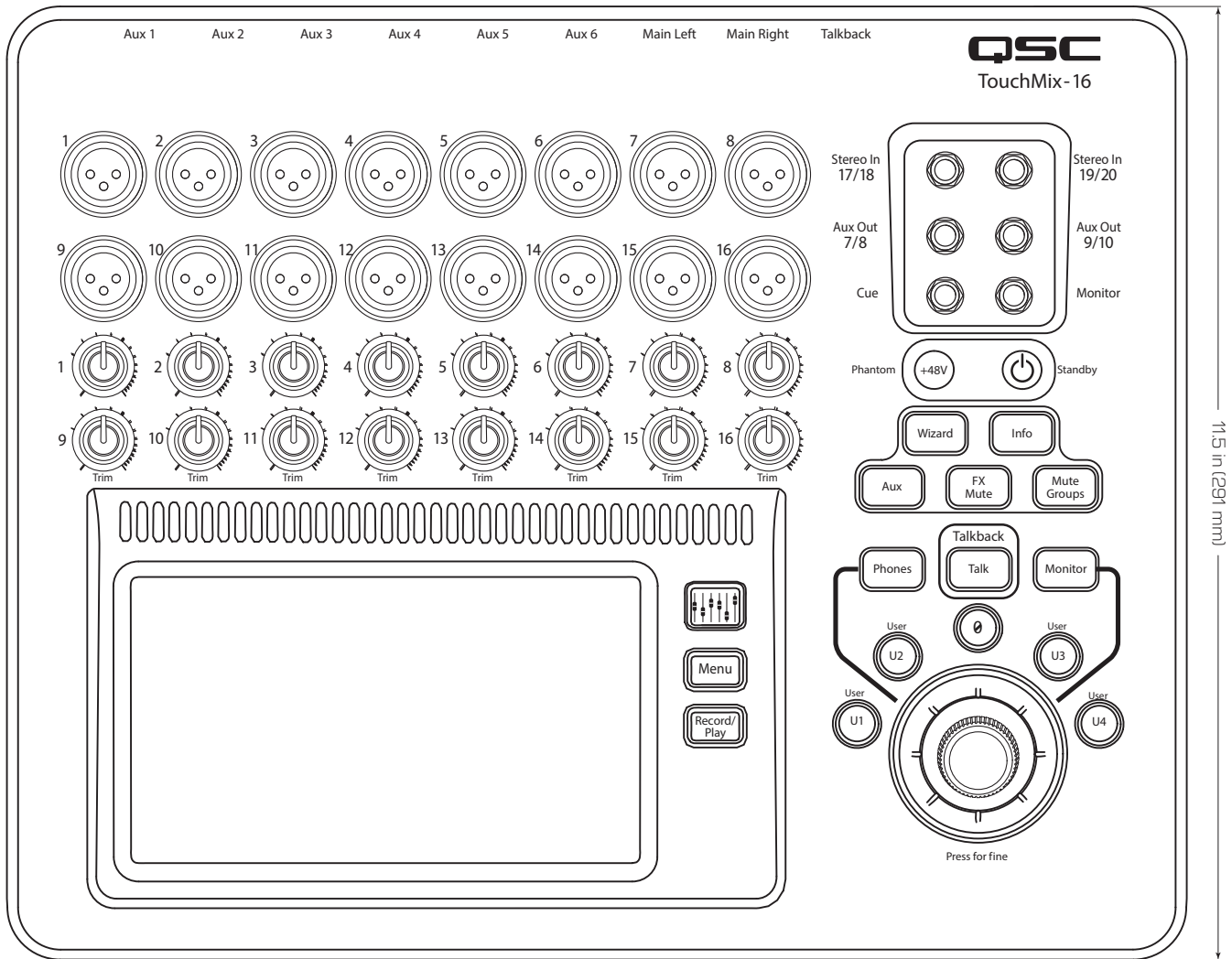
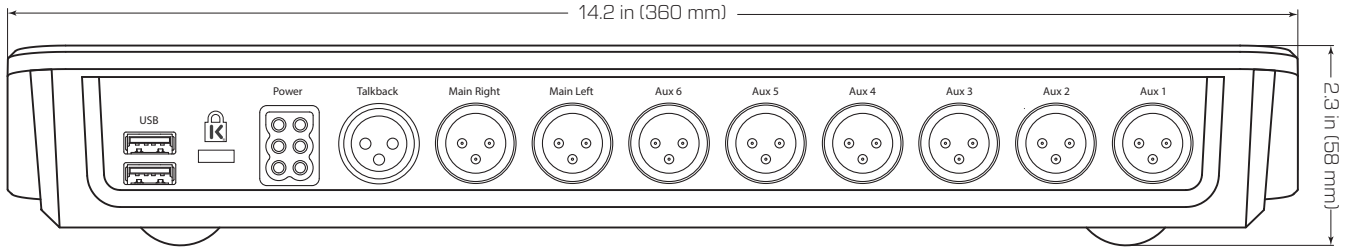

# TouchMix Block Diagram

## Mic/Line Input Channels

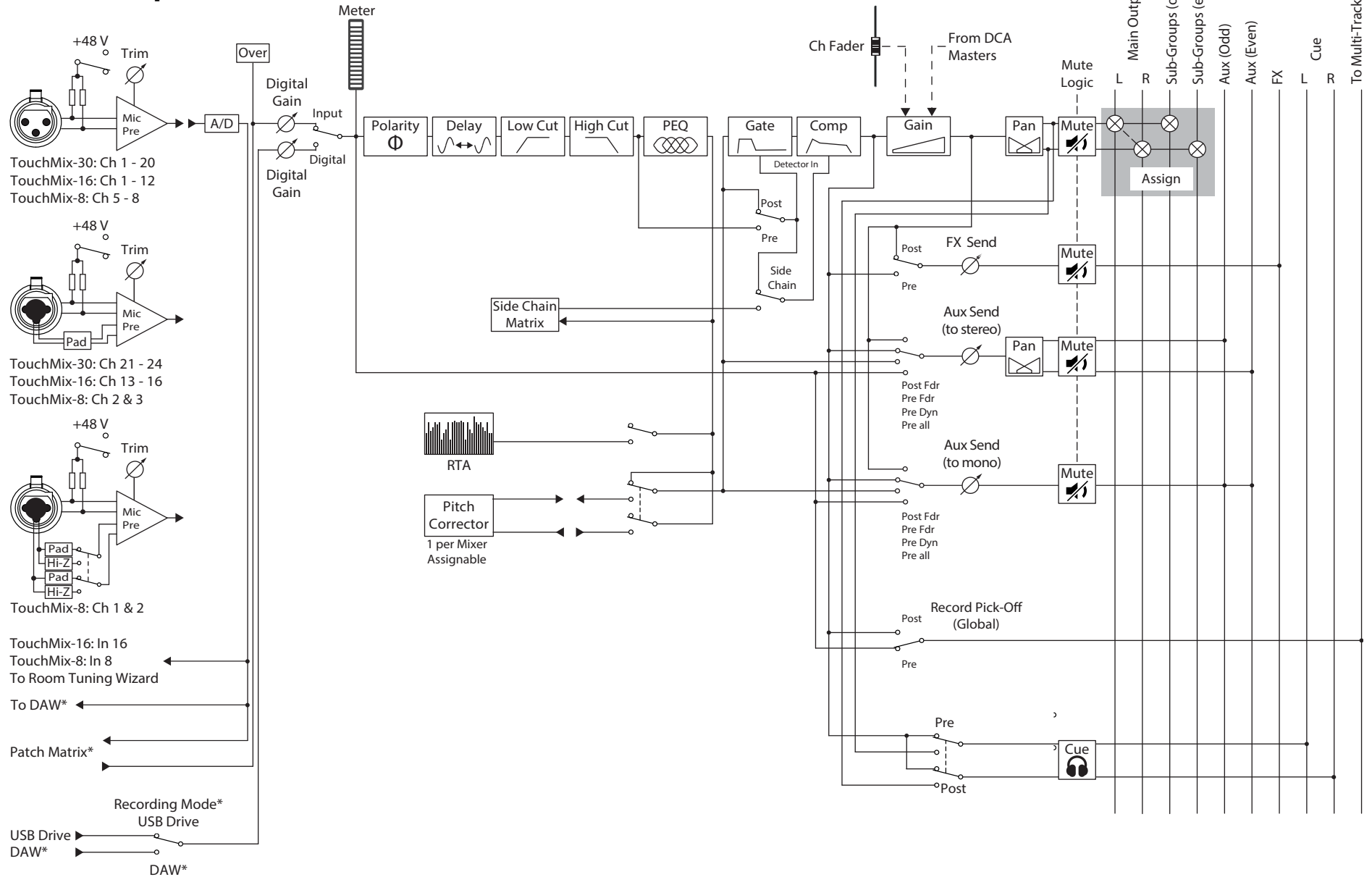

# Stereo Input Channels

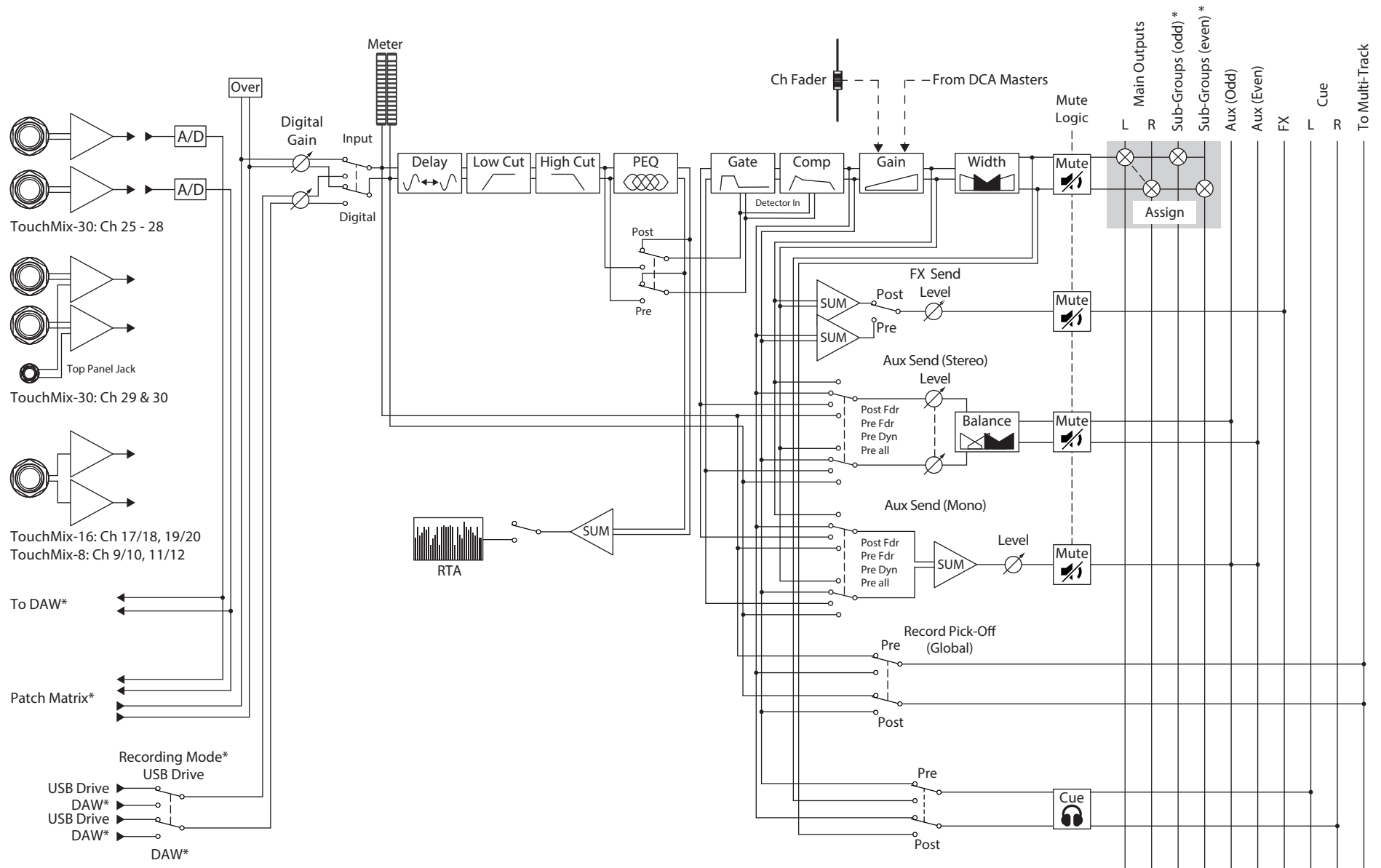

\* TouchMix-30 only

# Main Output

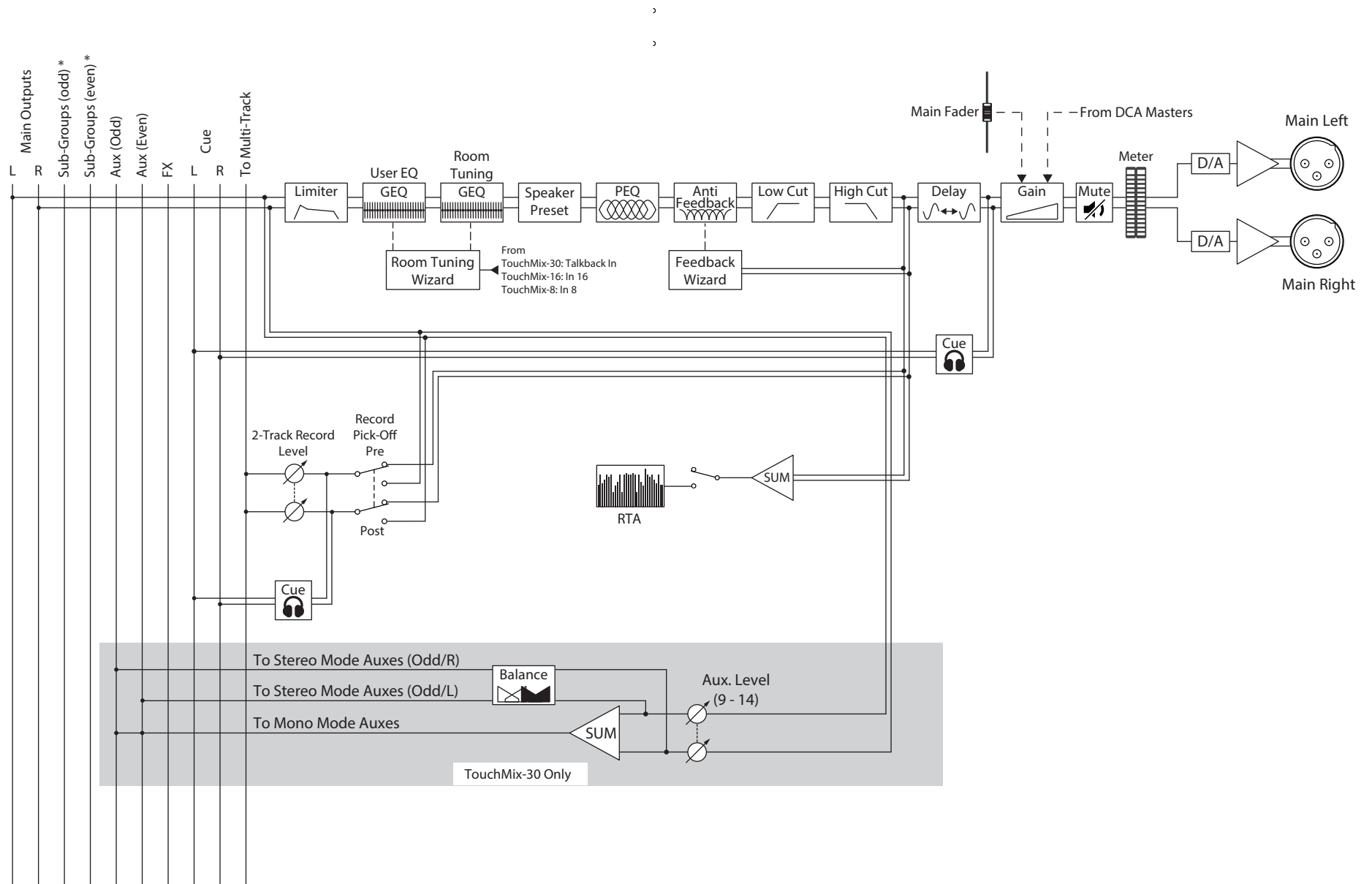

\* TouchMix-30 only

# Stereo Auxiliary Output

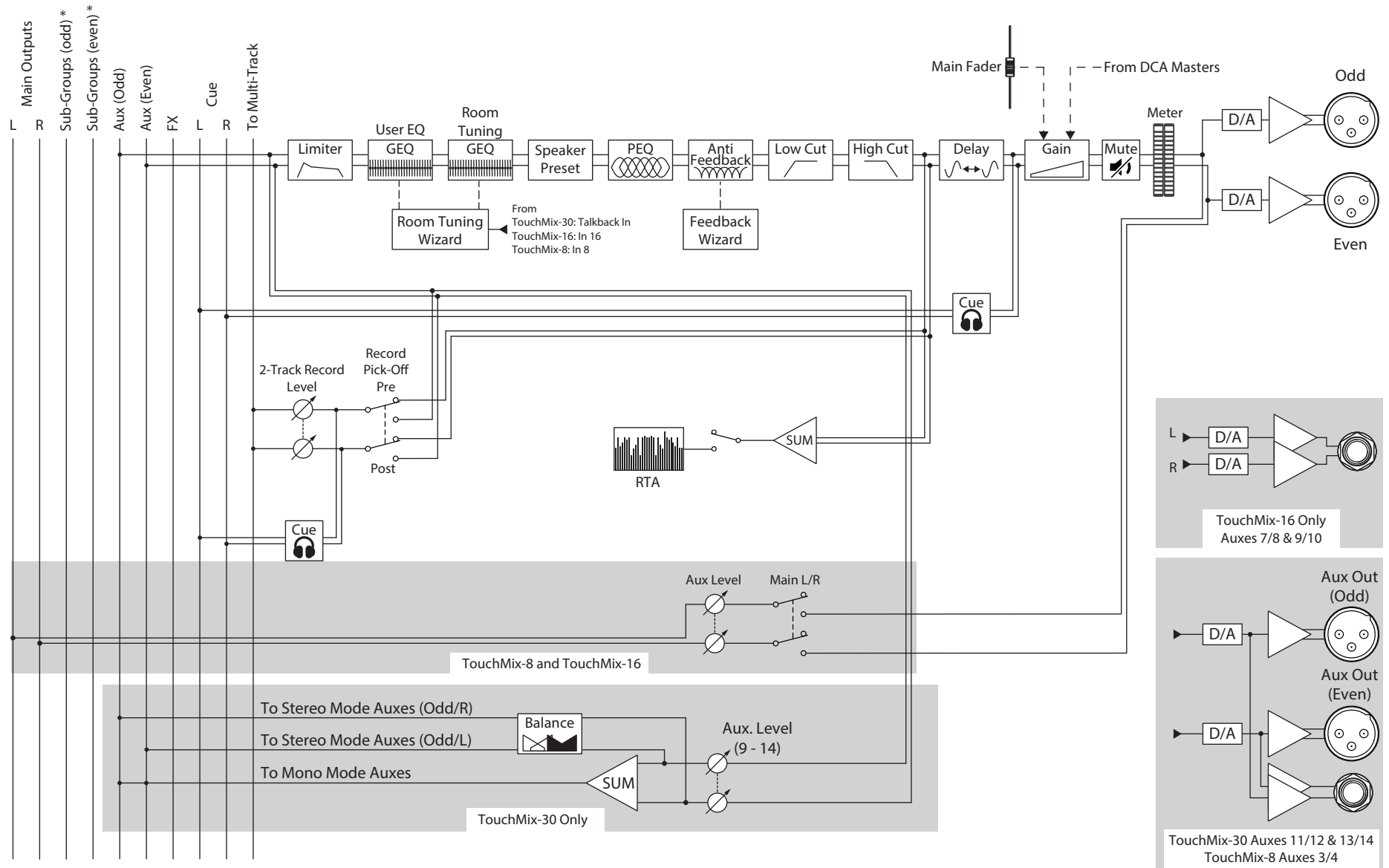

\* TouchMix-30 only

# Mono Auxiliary Output

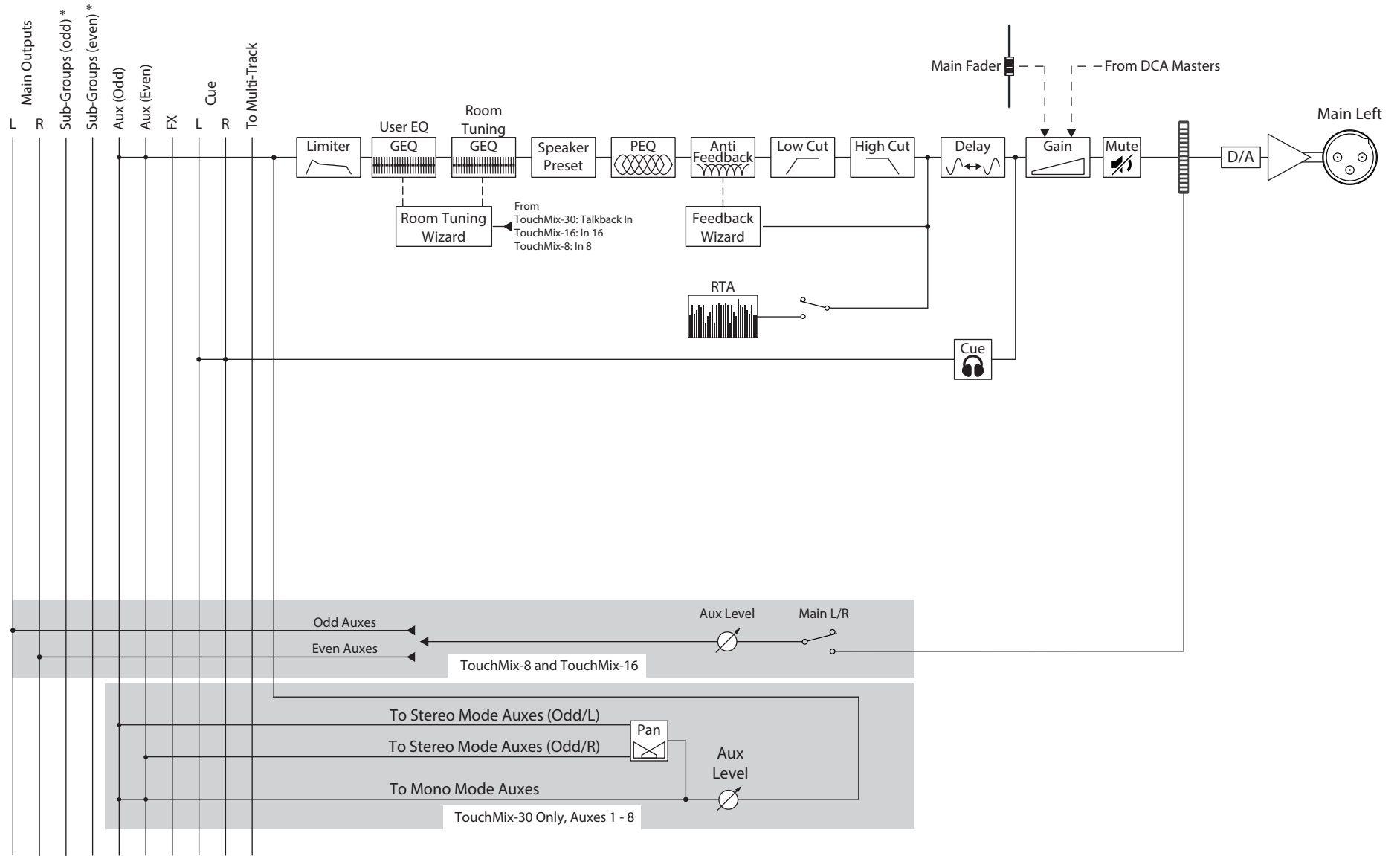

\* TouchMix-30 only



# Stereo Sub Group (TouchMix-30 only)

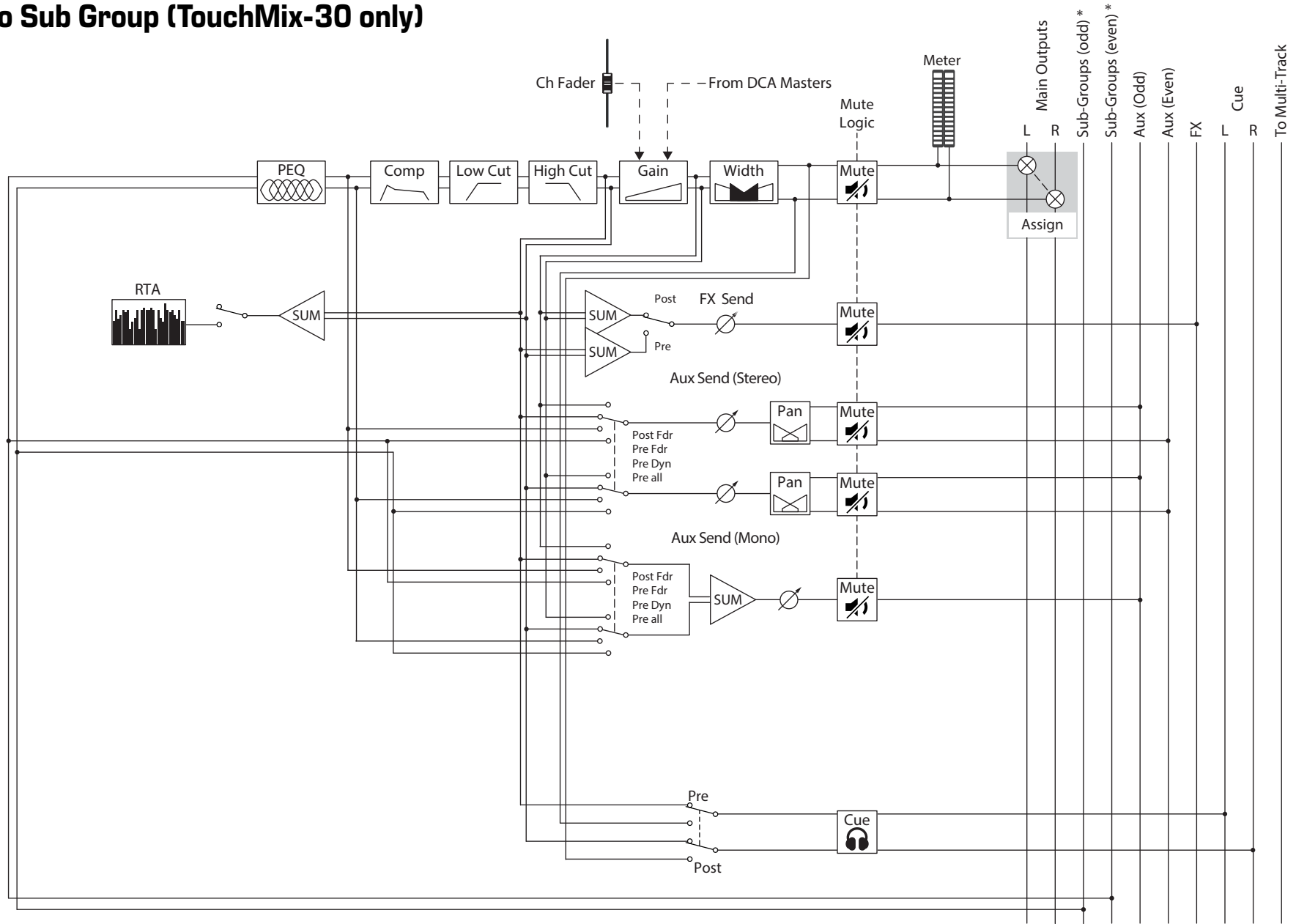

\* TouchMix-30 only

# Mono Sub Group (TouchMix-30 only)

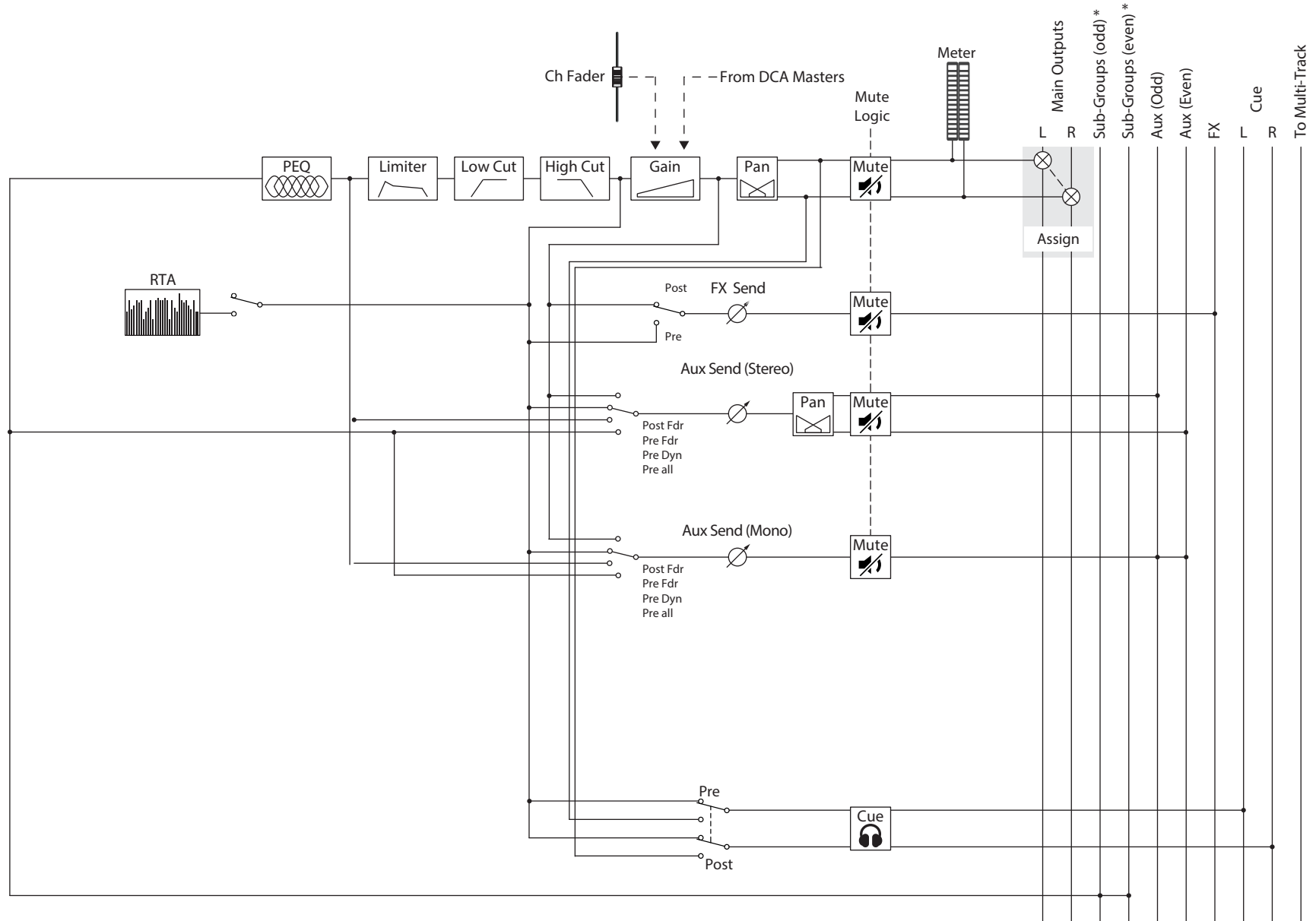

\* TouchMix-30 only

# Cue, Monitor, Talkback, Noise

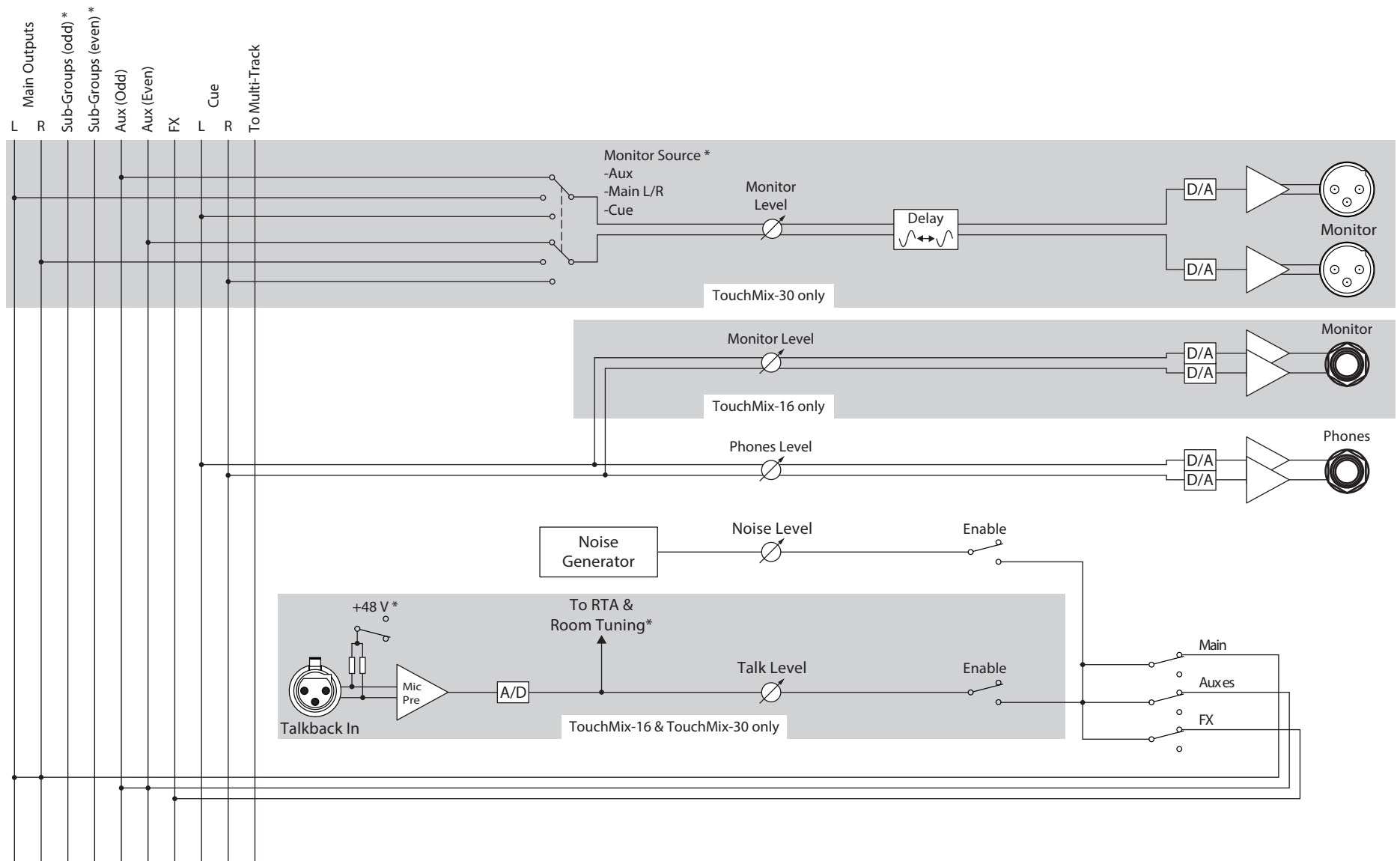

\* TouchMix-30 only

# FX Return

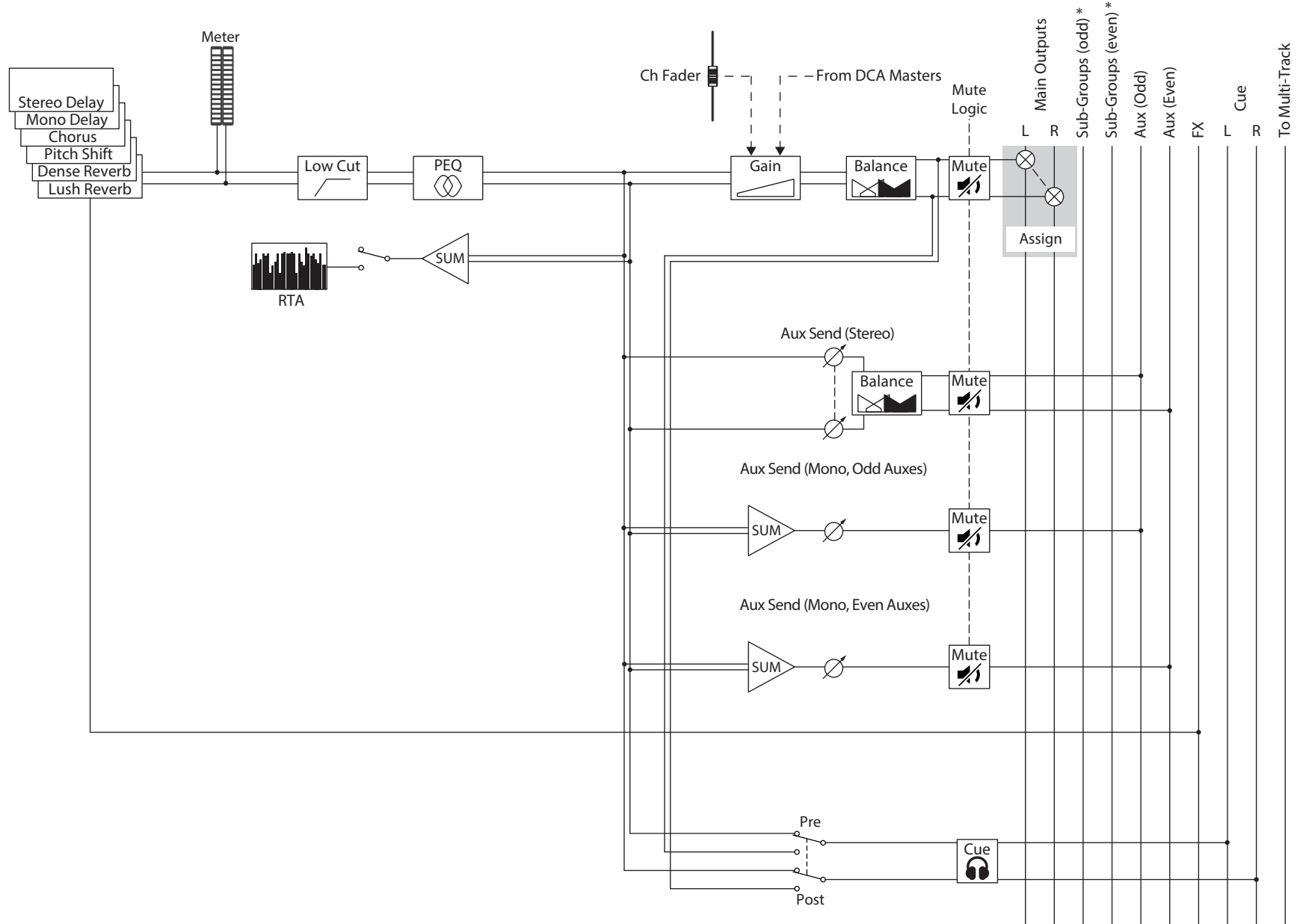

\* TouchMix-30 only

# 2-Track Playback

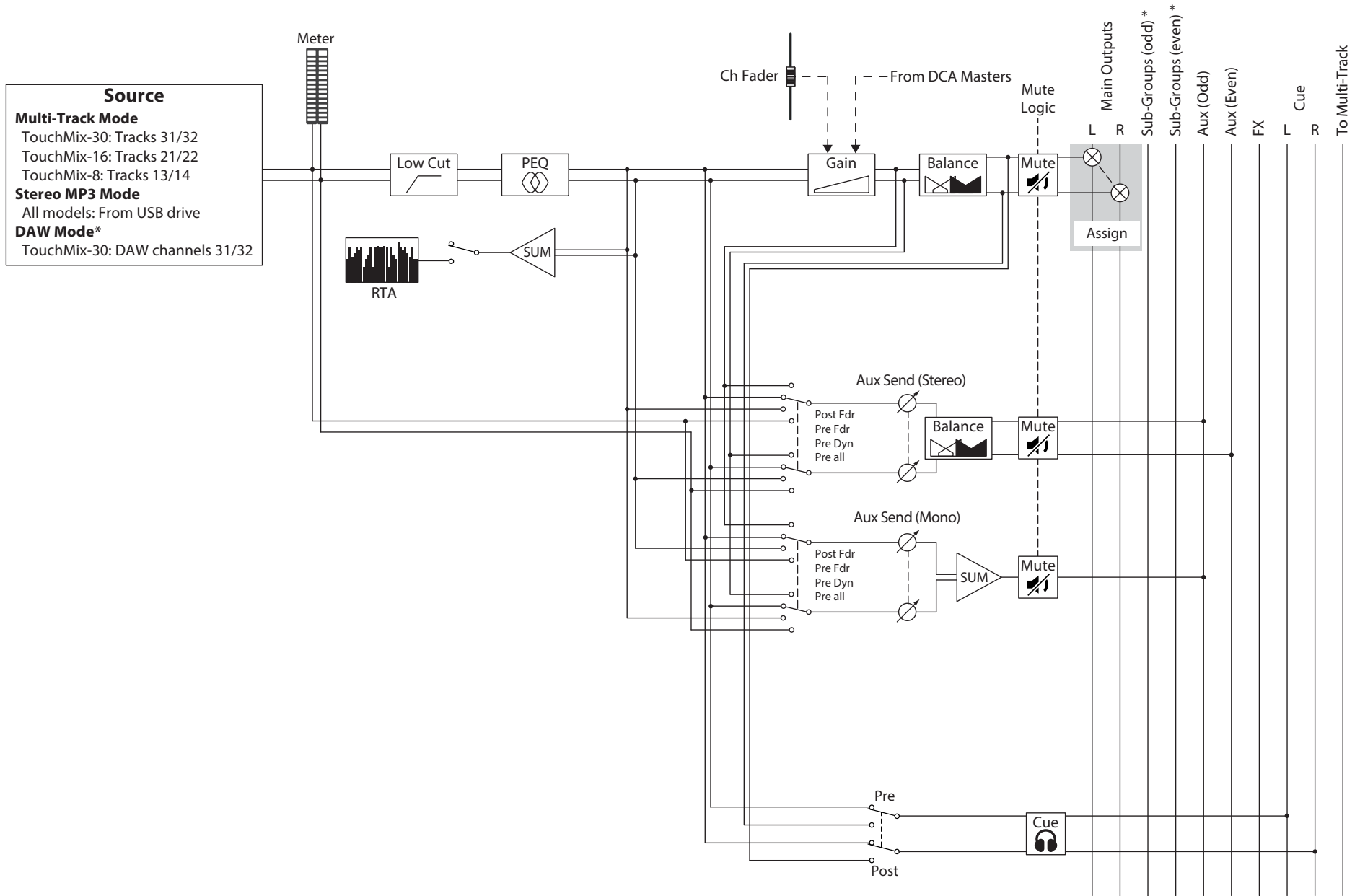

# RTA (Real Time Analyzer)

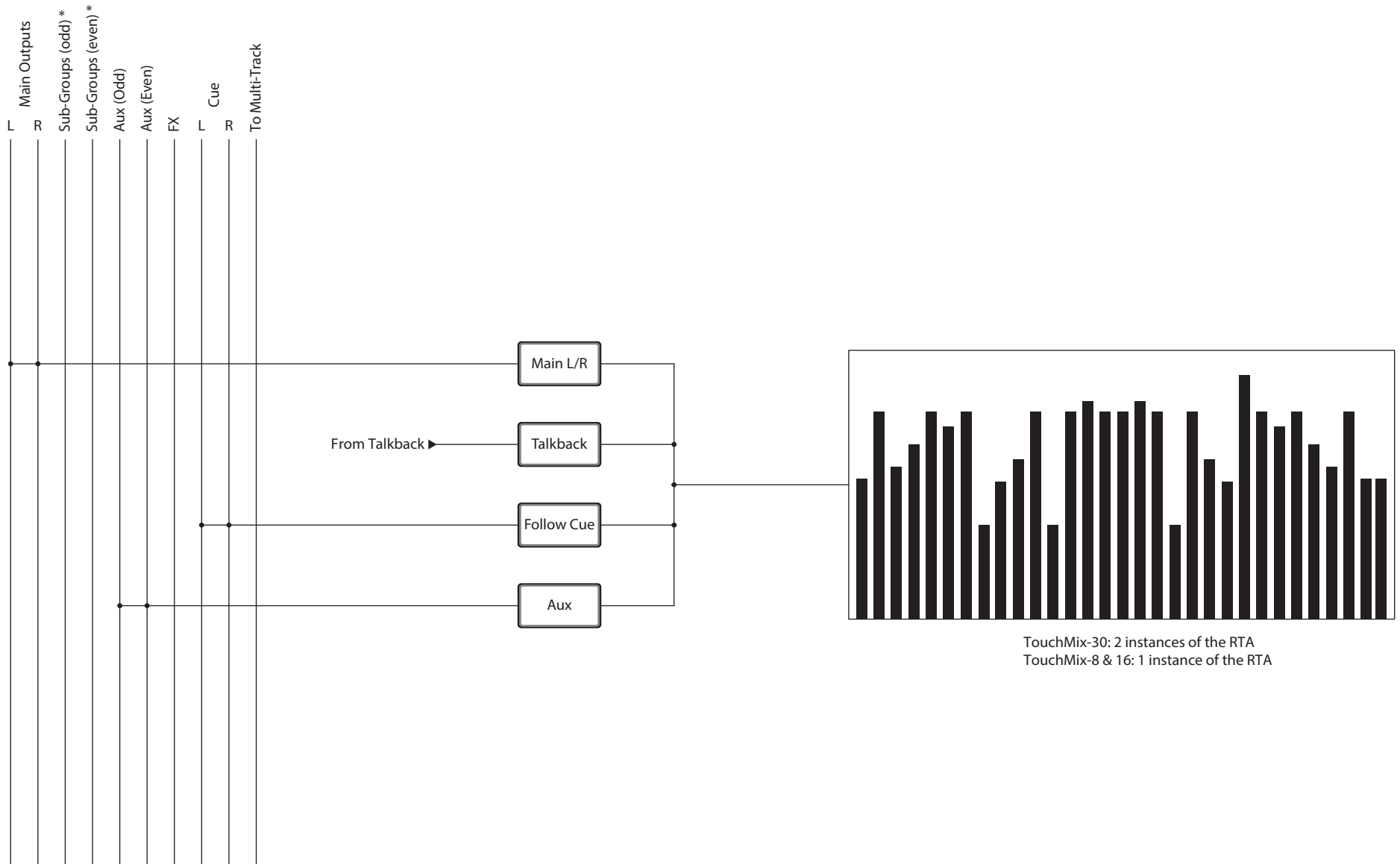

\* TouchMix-30 only



## Contact QSC

### QSC, LLC

Mailing Address:	1675 MacArthur Boulevard Costa Mesa, CA 92626-1468 U.S.
Main Number:	+1.714.754.6175
World Wide Web:	www.qsc.com

### Sales & Marketing:

Voice:	+1.714.957.7100 or 1.800.854.4079 toll free (U.S. only)
FAX:	+1.714.754.6174
e-mail:	info@qsc.com

### QSC Customer Support

#### Application Engineering and Technical Services

(Monday – Friday 7 AM to 5 PM PST (Excludes Holidays))

Voice	+1.714.957.7150 1.800.772.2834 toll free (U.S. only)
FAX	+1.714.754.6173

### QSC Self-Help Portal

Access our Self-Help Portal for additional information, FAQs, and documents. You may also register or login to open a case with QSC Technical Services.

<https://qscprod.force.com/selfhelpportal/s/>